

DC MOTOR

40W

□90mm

DIMENSIONS

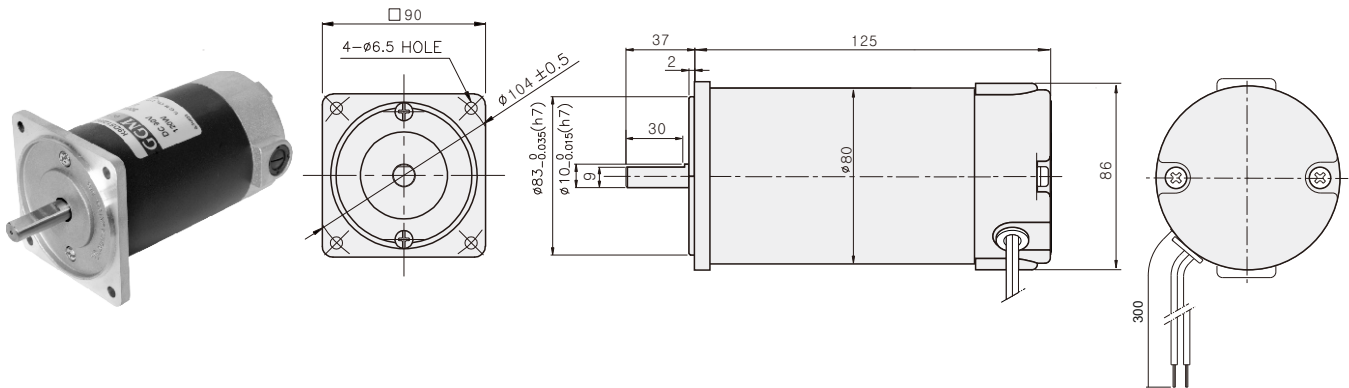

CONNECTION DIAGRAMS

RED ← ⊕ CW
 BLACK ← ⊕ CCW

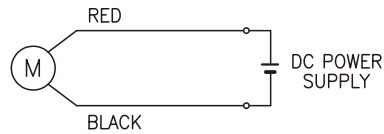

SPECIFICATIONS

Model	Output (w)	Voltage (V)	RATED			Start T. (N·m/kgf·cm)	Starting Current (A)
			Speed (rpm)	Torque (N·m/kgf·cm)	Current (A)		
K9D□40N1	40	12	3000	0.13/1.3	6.1	1.43/14.3	64
K9D□40N2		24					
K9D□40N3		90					

* □ : SHAFT SHAPE (S : STRAIGHT, G : PINION)

GEARHEAD

DIMENSIONS

DECIMAL GEARHEAD

K9G10BX

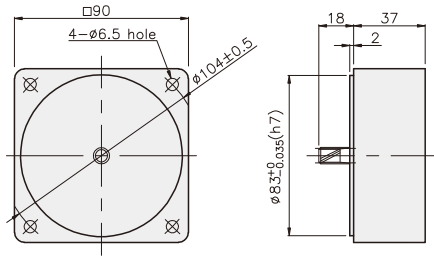

GEARHEAD

K9G□B(C)

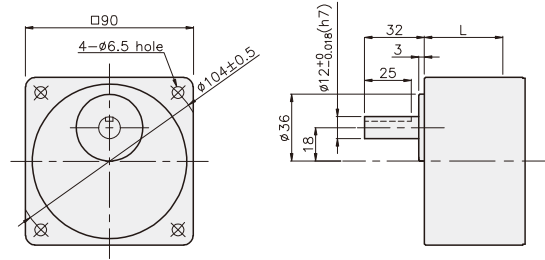

KEY SPEC

● KEY

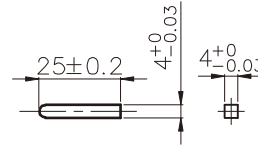

● KEY GROOVE

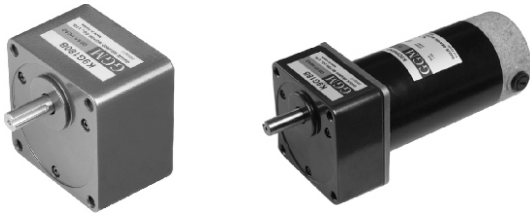
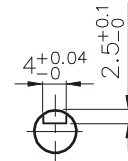

DIMENSION TABLE

Part No	L	Application Model	Mounting BOLT
01	42	K9G3~18B(C)	M6 P1.0 X 65
02	60	K9G20~200B(C)	M6 P1.0 X 80
03	37	K9G10BX	M6 P1.0 X 120

WEIGHT

PART	WEIGHT(kg)	
MOTOR	1.88	
K9G10BX	0.60	
GEAR HEAD	K9G3~18B(C)	0.78
	K9G20~40B(C)	1.04
	K9G50~200B(C)	1.14

K9DG40N□ + K9G□B(C)

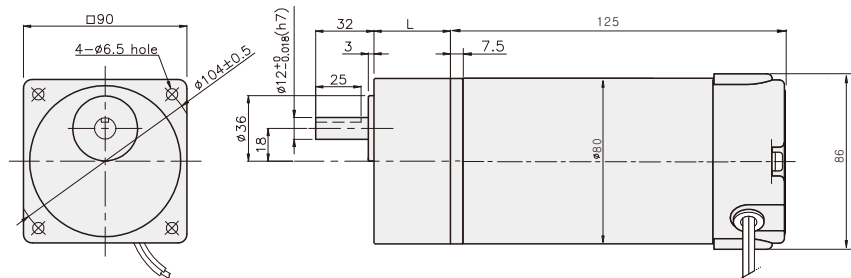

RATED TORQUE OF GEARHEAD

● K9G□B(C)

unit = above : N·m / below : kgf·cm

Model	Speed (rpm)	1000	833	600	500	400	333	300	240	200	167	150	120	100	83	75	60	50	40	33	30	25	20	17	15
		Ratio	3	3.6	5	6	7.5	9	10	12.5	15	18	20	25	30	36	40	50	60	75	90	100	120	150	180
K9DG40N□	0.32	0.38	0.53	0.63	0.79	0.95	1.05	1.31	1.58	1.89	1.89	2.37	2.84	3.41	3.78	4.26	5.11	6.39	7.66	8.52	10	10	10	10	10
	3.2	3.8	5.3	6.3	7.9	9.5	10.5	13.1	15.8	18.9	18.9	23.7	28.4	34.1	37.8	42.6	51.1	63.9	76.6	85.2	100	100	100	100	100

* Gearhead and decimal gearhead are sold separately.

* The code in □ of gearhead model is for gear ratio.

* color indicates that the output shaft of the geared motor rotates in the same direction as the output shaft of the motor.

* Others indicate rotation in the opposite direction.

* If you are to have less ratio than the ratio in the table, you can install the decimal gearhead, which has one tenth of the ratio, between the gearhead and the motor. In this case, the permissible torque is 10 N·m / 100 kgf·cm.