

# SPEED CONTROL MOTORS(SU)

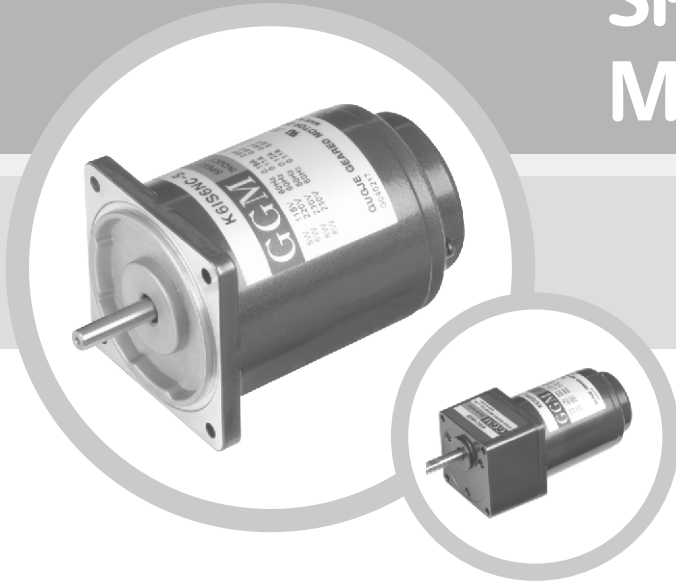

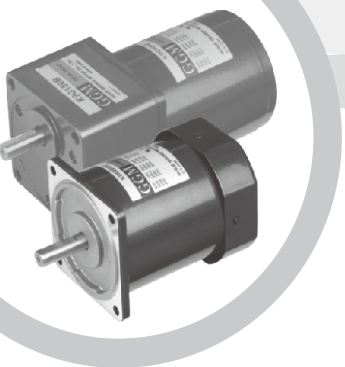

## [Characteristics of Speed Control Motor]

### 1. Characteristics of Speed Control Motor

- By using it with the speed controller, a wide range of speed can be controlled (50Hz : 90~1400rpm, 60Hz : 90~1700rpm). The speed can be controlled easily with the speed controller.
- Depending on the type of speed controller, it can be combined with the motor for various purposes such as speed-control, braking, slow run, slow stop, etc.
- Built in T.G. (Tacho Generator) to control the feedback. Thus, even if the power frequency is changed but the rotating numbers does not change.
- When the speed control motor with an electronic brake is used with the speed controller, instantaneous braking and electronic braking operate simultaneously for strong braking power.
- The speed control motor with an electronic brake also has a non-excitation run type of electronic brake. Even if the power is off, braking is operated to maintain braking of a load.
- Speed control motors are consisted of the induction motor the reversible motor and the speed control motor with an electronic brake which are small AC motor. The applicable motor should be selected for appropriate uses.
- Output range of the induction motor is 6W~90W (unit types are 6W~180W). The reversible motor has an output range of 6W~40W and the electronic brake motor has an output range of 6W~40W. (However, SR types are 6W~90W.)

### 2. Selection Method

#### (1) Selection of motor and controller

- Is speed control needed only?
- Is instantaneous braking needed?
- Is maintenance of braking power needed?
- How much is the output of the applicable motor?
- Are the slow run, slow stop functions needed?

According to the above conditions, the types of speed control motors and speed controllers are selected.

#### (2) Selection of gear ratio of gearhead

- When the number of rotations of the output shaft of the gear requires A rpm to B rpm, the gear ratio is calculated by using the higher number of rotations (B rpm). For the AC speed control motor, the number of rotations for the motor is calculated with 1300 rpm. (This is the reason for the output torque and the range of use are large at 1300 rpm.)

$$\text{deceleration ratio } i = \frac{1300[\text{rpm}]}{N^2[\text{rpm}]}$$

#### (3) Highest number of rotations and lowest number of rotations of the motor shaft

- When the highest number of rotations is NH and the lowest number of rotations is NL, they are as follows.
- Highest number of rotations of the required motor:  
NH = B x i [rpm]
- Lowest number of rotations of the required motor:  
NL = A x i [rpm]

#### (4) Required torque of the motor

$$T_M = \frac{T_L}{i \times \eta} = [\text{gf} \cdot \text{cm}]$$

The required torque of the motor is found as follows.

$T_M$  : Required torque of the motor [g · cm]

$T_L$  : Torque necessary to operate actual load [g · cm]

$i$  : Reduction ratio

$\eta$  : Efficiency of the gearhead

#### (5) Selection of the motor

- The motor is decided by the required torque  $T_M$ , rotational frequencies NL~NH and the torque-number of rotations curve (hereafter, N-T curve).
- In the case of the AC speed control motor (Fig. 1) of the curves, the moment curve (i curve) selects the motor below the limit curve. (Even in the area above the limit curve, if the surface temperature of the motor is less than 90°C, then there are no problems with use.)

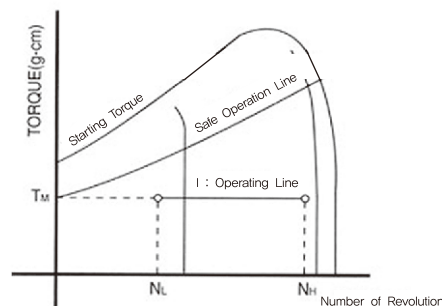

(Fig. 1) Torque-Number of Revolutions (N-T) Curve

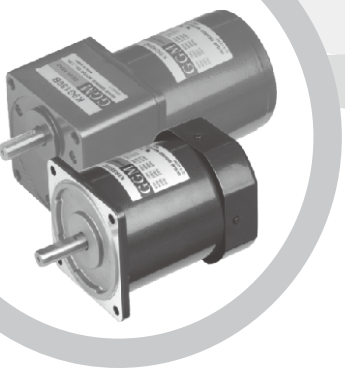

## (6) Selection of gearhead

- After the motor is selected in the above manner, the gearhead is decided with consideration of the torque size of the load. Confirm that the torque of the load is within the torque allowable by the gearhead.

### 3. Sample Calculation for Selection (Fig.2)

With single direction rotation of the belt conveyor, change the speed of the item being transported to 1m/minute, 2m/minute, and 4m/minute.

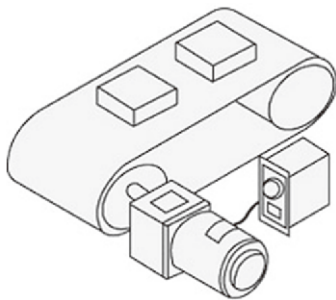

Drum diameter : 10cm  
 Operating torque : 30kg · cm  
 Power : Single phase 110V 60Hz  
 Instantaneous braking in emergencies, but no holding power.

#### (1) Motor and controller

- Rotation is in one direction and there is no holding power. Therefore, the induction motor is selected.

#### (2) Revolutions of output shaft of gearhead

- The number of rotations of the gearhead shaft when the belt conveyor speed is 1m/minute.

$$\text{Number of rotations} = \frac{\text{Speed of belt conveyor}}{\text{Outer diameter of drum}} = \frac{100}{10 \pi} = 3.18[\text{rpm}]$$

- Number of rotations of the gearhead shaft when the belt conveyor speed is 2m/minute.

$$\text{Number of rotations} = \frac{\text{Speed of belt conveyor}}{\text{Outer diameter of drum}} = \frac{200}{10 \pi} = 6.37[\text{rpm}]$$

- Number of rotations of the gearhead shaft when the belt conveyor speed is 4m/minute.

$$\text{Number of rotations} = \frac{\text{Speed of belt conveyor}}{\text{Outer diameter of drum}} = \frac{400}{10 \pi} = 12.74[\text{rpm}]$$

#### (3) Gear ratio

- The gear ratio is calculated using the higher number of rotations of the gearhead.

$$\frac{\text{Number of rotations of the motor}}{\text{Number of rotations of the gearhead}} = \frac{1300}{12.74} = 102$$

Using 102, since there is no such reduction ratio as 1/102, 1/100 is selected.

#### (4) Number of rotations of motor shaft

- The number of rotations of the motor shaft is calculated by the number of rotations of the gearhead shaft x reduction ratio for each speed of the belt conveyor to get the following.
  - 3.18 x 100 = 318 [rpm]
  - 6.37 x 100 = 637 [rpm]
  - 12.74 x 100 = 1274 [rpm]

#### (5) Required torque of motor

The transfer efficiency of a gearhead with gear ratio 100 is 66%, so the required torque of the motor is

$$\frac{\text{Operating torque}}{\text{Gear ratio x Efficiency}} = \frac{30}{100 \times 0.66} = 0.45[\text{kg} \cdot \text{cm}]$$

#### (6) Selection of motor

- From the N-T curve of the induction motor, it can be seen that the K8IG25NC-S motor and the K8G100B gearhead can be combined to use. However, in such a case, make sure that the inertia load should fall within the specification of the selected motor.

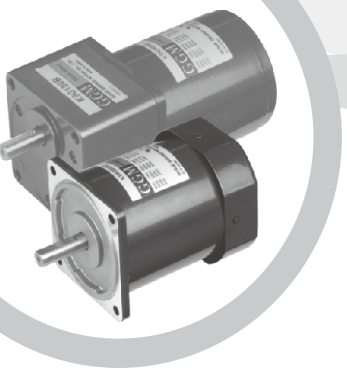

## 4. The Principle of Speed Control

### (1) The principle of speed control

- (Fig. 3) is the basic speed control structure of the close loop current control method. The following are explanations of close loop speed control.

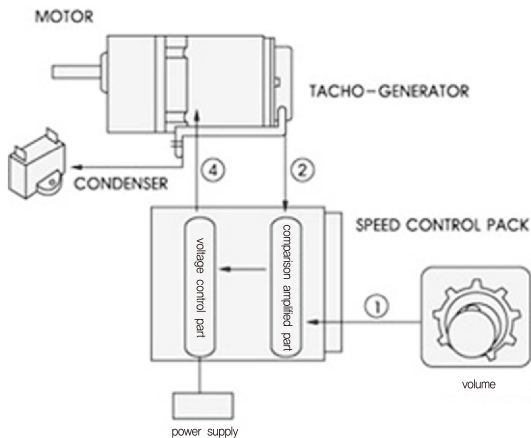

(Fig. 3) Basic structure of speed control for the close loop voltage control method

- If Tacho-Generator changes the voltage that is proportional to the rotations, make comparison between the number of rotations of the motor and the voltage preset by the volume.
- This difference in voltage is called "comparative voltage".
- Comparative voltage operates the motor through the voltage amplifier and the voltage controller.
- Comparative voltage is mostly controlled by zero-crossing. Number of rotations is decided by the value that the speed controller selects.
- Even when the load changes, the number of rotations does not change. When the Tacho-Generator changes, the number of rotations immediately changes with the value.
- Accordingly, close loop speed control detects the number of rotations of the motor and controls the operating voltage to maintain it constantly.

### (2) Primary voltage control by close loop

- The relationship between the torque of the induction motor and the number of rotations is as follows (Fig. 4) when the applied voltage (primary voltage) of the motor is changed.

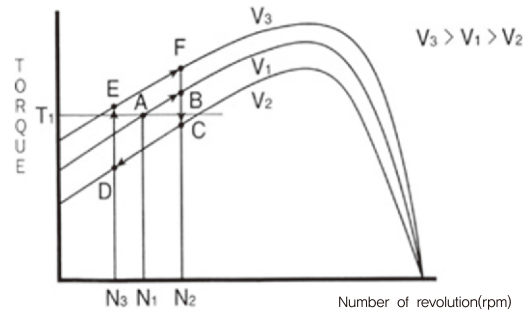

(Fig. 4)

- The current voltage is  $V_1$ , the torque of the load is  $T_1$  and the number of rotations is  $N_1$ . That point is A. Speed is increased to B and when the voltage is changed from  $V_1$  to  $V_2$ , then it moves to C.
- At C, the torque of the load  $T_1$  is larger than the torque of the motor, thus the number of rotations are lower than  $N_2$ .
- When the number of rotations becomes  $N_3$  and the voltage is raised to  $V_3$ , then the generated torque becomes larger than the torque of the load to move to E, and then the speed increases again toward F.
- To stabilize the number of rotations, it has to make loop smaller like  $C \rightarrow D \rightarrow E \rightarrow F$  by controlling the primary voltage.
- During the primary voltage control by close loop, to meet the changes according to the number of rotations of the motor, it should have the primary voltage controlled and maintain the number of rotations constant.

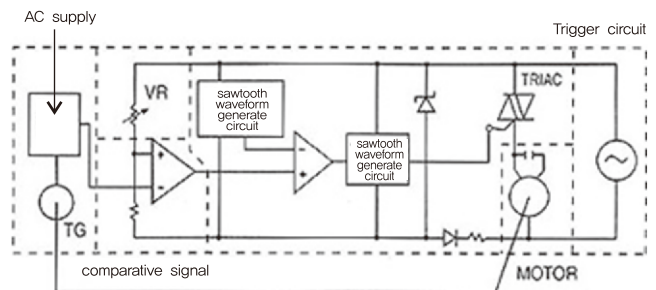

(Fig. 5)

### (3) Operation of speed controller

- The speed controller is explained in (Fig. 5).
- Number of rotations of the motor comes from the Tacho-Generator through feedback voltage through the rectifying circuit.
- The difference between the selected voltage of the speed controller which was controlled in the VR and the feedback voltage is amplified in the comparative amplifier.



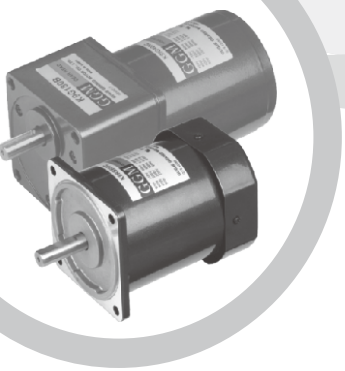

- A trigger signal is generated from the sawtooth waveform which comes from the sawtooth waveform generator, comparator from the comparative signal and triac from the trigger circuit.
- The angle of the triac is controlled with the trigger signal to control voltage in the motor.
- This makes the number of rotations of the motor constant, thereby controlling it. Refer to (Fig. 6).

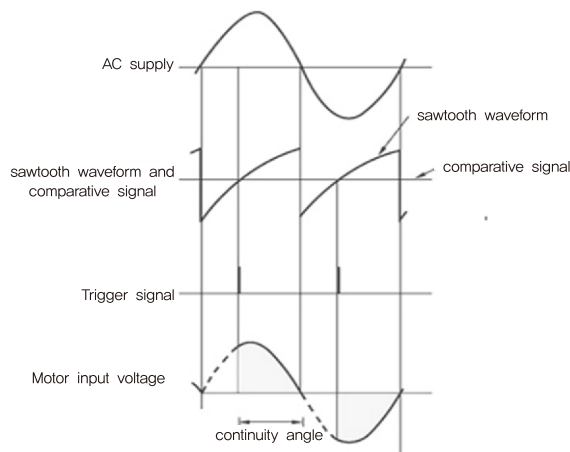

(Fig. 6)

## 5. Limit of Use

### (1) Limit curve

- In the AC speed control motor N-T graph (Fig. 7), the area below the limit curve is called the continuous operation area.
- The limit curve does not go beyond the highest temperature allowed by the motor (continuous for induction motors and 30 minutes rating for reversible motors) and because continuous operation is possible, it is decided by the temperature of the motor.

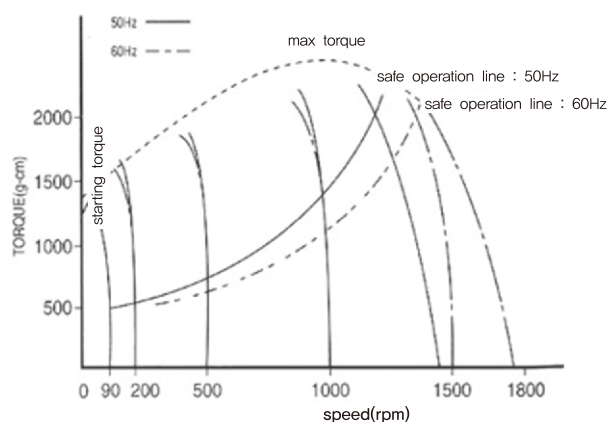

(Fig. 7) Torque-number of revolutions N-T curve

- Our speed control motor has a class E insulation and the permitted temperature of the winding section is 120°C. Therefore, if the temperature of the winding section is less than 120°C, continuous operation is possible, but it is difficult or the user to measure the temperature of the winding section, continuous operation is generally possible when the surface temperature of the motor housing is less than 90°C. The difference between the winding section of the motor and the housing surface is generally between 10°C~20°C.

### (2) The meaning of for less than 90°C surface temperature of the motor housing

- The highest part of the motor's rising temperature is the winding section. Thus, the highest allowable temperature is decided by the insulation level of the winding section. (Our small AC motor has a class E insulation and the highest allowable temperature is 120°C.)
- The difference between the temperature of the surface of the motor and the winding section is about 10°C~20°C. (A motor with a cooling fan has about 30°C because the cooling fan cools the surface of the motor.)
- When the temperature of the winding section is 120°C, the surface temperature is about 100°C. Therefore, 90°C is the sufficient value.

### (3) Range of use according to instantaneous braking

- Instantaneous braking uses direct current which is half-wave rectified current in the motor thus causing the temperature of the motor to rise rapidly.
- In the N-T graph, the limit curve is in the case of continuous operation, therefore, if instantaneous braking is applied often, the range of the limit decreases.
- For instantaneous braking, temperature rises by frequent braking, thus care should be taken so that the surface temperature of the motor does not exceed 90°C.

## SPEED CONTROL MOTOR - SU SERIES

**6W**

□60mm

**INDUCTION MOTOR**

K6IS6N□-SU

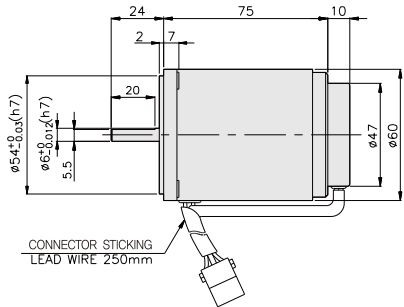
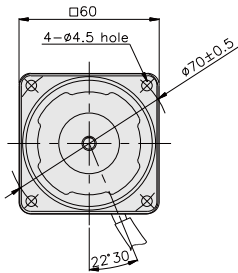

### SPECIFICATIONS

6W continuous rating, four poles

Model	Voltage (V)	Frequency (Hz)	Speed Range (rpm)	Permissible Torque		Start T. (N*m/Kgf*cm)	Current (A)	Condenser (μF)
				1200rpm (N*m/Kgf*cm)	90rpm (N*m/Kgf*cm)			
K6I□6NJ-SU	100	50	90 ~ 1400	0.05/0.5	0.03/0.3	0.029/0.29	0.28	3
		60	90 ~ 1700					
K6I□6NU-SU	110	60	90 ~ 1700	0.05/0.5	0.03/0.3	0.03/0.3	0.24	2
	115							
K6I□6NL-SU	200	50	90 ~ 1400	0.05/0.5	0.029/0.29	0.03/0.3	0.19	0.8
		60	90 ~ 1700					
K6I□6NC-SU	220	50	90 ~ 1400	0.05/0.5	0.029/0.29	0.029/0.29	0.2	0.6
		60	90 ~ 1700					
	230	50	90 ~ 1400					
		60	90 ~ 1700					
K6I□6ND-SU	240	50	90 ~ 1400	0.05/0.5	0.029/0.29	0.03/0.3	0.21	0.5

\* □ : SHAFT SHAPE (S : STRAIGHT, G : PINION)

### RATED TORQUE OF GEARHEAD

● Single-phase 100V/115V

unit = above : N·m / below : Kgf·cm

Model	Ratio	Gearhead Ratio																								
		3	3.6	5	6	7.5	9	10	12.5	15	18	20	25	30	36	40	50	60	75	90	100	120	150	180	200	250
K6I□6N□-SU K6G□B(C)	1200	0.12 1.2	0.15 1.5	0.20 2.0	0.24 2.4	0.30 3.0	0.36 3.6	0.41 4.1	0.51 5.1	0.61 6.1	0.73 7.3	0.73 7.3	0.91 9.1	1.09 10.9	1.31 13.1	1.46 14.6	1.64 16.4	1.97 19.7	2.46 24.6	2.95 29.5	3 30	3 30	3 30	3 30	3 30	3 30
	90	0.07 0.7	0.08 0.8	0.12 1.2	0.14 1.4	0.18 1.8	0.21 2.1	0.23 2.3	0.26 2.6	0.32 3.2	0.42 4.2	0.42 4.2	0.53 5.3	0.63 6.3	0.76 7.6	0.85 8.5	0.95 9.5	1.14 11.4	1.43 14.3	1.71 17.1	1.90 19.0	2.28 22.8	2.85 28.5	3 30	3 30	3 30

● Single-phase 200V/240V

unit = above : N·m / below : Kgf·cm

Model	Ratio	Gearhead Ratio																								
		3	3.6	5	6	7.5	9	10	12.5	15	18	20	25	30	36	40	50	60	75	90	100	120	150	180	200	250
K6I□6N□-SU K6G□B(C)	1200	0.12 1.2	0.15 1.5	0.20 2.0	0.24 2.4	0.30 3.0	0.36 3.6	0.41 4.1	0.51 5.1	0.61 6.1	0.73 7.3	0.73 7.3	0.91 9.1	1.09 10.9	1.31 13.1	1.46 14.6	1.64 16.4	1.97 19.7	2.46 24.6	2.95 29.5	3 30	3 30	3 30	3 30	3 30	3 30
	90	0.07 0.7	0.08 0.8	0.12 1.2	0.14 1.4	0.18 1.8	0.21 2.1	0.23 2.3	0.29 2.9	0.35 3.5	0.42 4.2	0.42 4.2	0.53 5.3	0.63 6.3	0.76 7.6	0.85 8.5	0.95 9.5	1.14 11.4	1.43 14.3	1.71 17.1	1.90 19.0	2.28 22.8	2.85 28.5	3 30	3 30	3 30

- \* Gearhead and decimal gearhead are sold separately.
- \* The code in □ of gearhead model is for gear ratio.
- \*      color indicates that the output shaft of the geared motor rotates in the same direction as the output shaft of the motor. Others indicate rotation in the opposite direction.
- \* If you are to have less ratio than the ratio in the table, you can install the decimal gearhead, which has one tenth of the ratio, between the gearhead and the motor. In this case, the permissible torque is 3N·m/30kgf·cm.
- \* RPM is based on motor's synchronous rpm (50HZ:1500rpm, 60HZ:1800rpm) and calculated by dividing gear ratio. Actual rpm is 2~20% less than indicating rpm according to load size.

## GEARHEADS

### CONNECTION DIAGRAMS

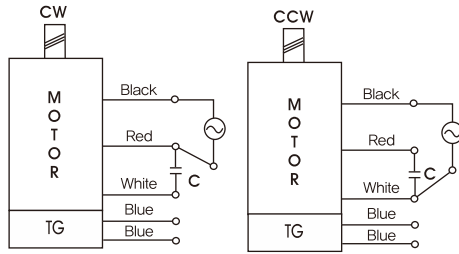

※The direction of motor rotation is as viewed from the front shaft end of the motor

### DIMENSIONS

K6G□B(C)



K6IG6N□-SU + K6G□B(C)



DECIMAL GEARHEAD

K6G10BX

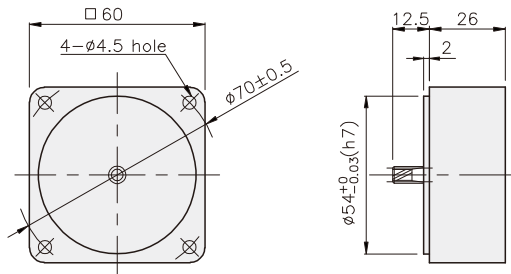

GEARHEAD

K6G□B(C)

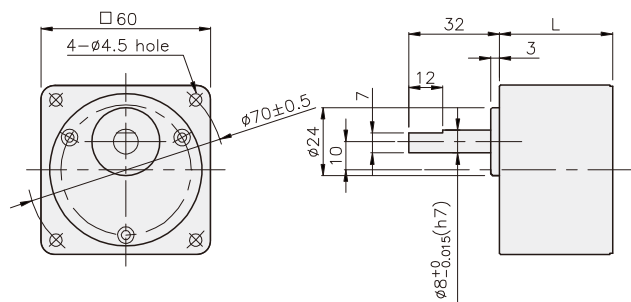

#### DIMENSION TABLE

PART No.	L	Application Model	Mounting BOLT
01	32	K6G3~18B(C)	M4 P0,7 X 50
02	40	K6G20~250B(C)	M4 P0,7 X 60
03	32	K6G10BX	M4 P0,7 X 85

#### WEIGHT

PART	WEIGHT(kg)	
MOTOR	0,79	
DECIMAL GEAR HEAD	0,22	
GEAR HEAD	K6G3~18B(C)	0,26
	K6G20~40B(C)	0,33
	K6G50~250B(C)	0,36

K6IG6N□-SU + K6G□B(C)

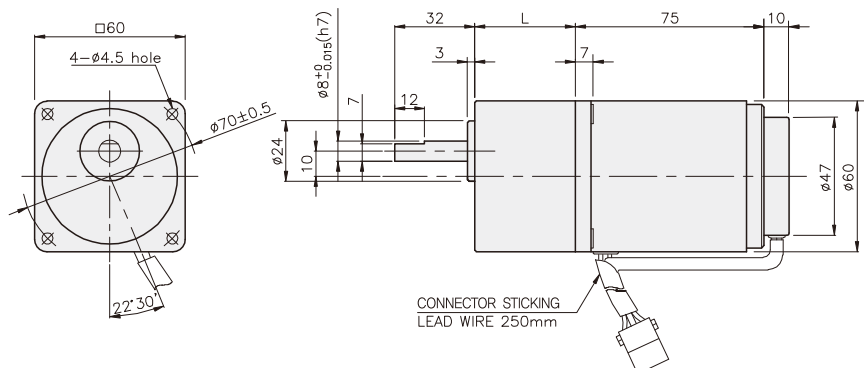

## SPEED CONTROL MOTOR - SU SERIES

### 15W

### □70mm

### INDUCTION MOTOR

K7IS15N□-SU

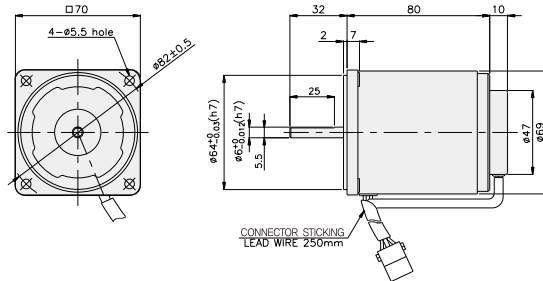
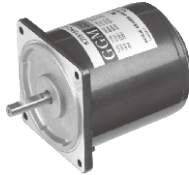

### SPECIFICATIONS

15W continuous rating, four poles

Model	Voltage (V)	Frequency (Hz)	Speed Range (rpm)	Permissible Torque		Start T. (N*m/Kgf*cm)	Current (A)	Condenser (μF)
				1200rpm (N*m/Kgf*cm)	90rpm (N*m/Kgf*cm)			
K7I□15NJ-SU	100	50	90 ~ 1400	0.125/1.25	0.045/0.45	0.07/0.7	0.55	5
		60	90 ~ 1700					
K7I□15NU-SU	110	60	90 ~ 1700	0.125/1.25	0.045/0.45	0.07/0.7	0.47	4.5
	115					0.075/0.75	0.5	
K7I□15NL-SU	200	50	90 ~ 1400	0.125/1.25	0.04/0.4	0.08/0.8	0.3	1.5
		60	90 ~ 1700			0.085/0.85	0.31	
K7I□15NC-SU	220	50	90 ~ 1400	0.125/1.25	0.04/0.4	0.06/0.6	0.29	1
		60	90 ~ 1700				0.105/1.05	
		50	90 ~ 1400	0.125/1.25		0.065/0.65	0.3	
		60	90 ~ 1700				0.105/1.05	
K7I□15ND-SU	240	50	90 ~ 1400	0.125/1.25	0.04/0.4	0.07/0.7	0.32	1

\* □ : SHAFT SHAPE (S : STRAIGHT, G : PINION)

### RATED TORQUE OF GEARHEAD

#### ● Single-phase 100V/115V

unit = above : N·m / below : Kgf·cm

Model	Ratio	Speed(rpm)																							
		3	3.6	5	6	7.5	9	10	12.5	15	18	20	25	30	36	40	50	60	75	90	100	120	150	180	200
K7I□15N□-SU K7G□B(C)	1200	0.30 3.0	0.36 3.6	0.51 5.1	0.61 6.1	0.76 7.6	0.91 9.1	1.01 10.1	1.27 12.7	1.52 15.2	1.82 18.2	1.82 18.2	2.28 22.8	2.73 27.3	3.28 32.8	3.65 36.5	4.10 41.0	4.92 49.2	5 50	5 50	5 50	5 50	5 50	5 50	5 50
	90	0.11 1.1	0.13 1.3	0.18 1.8	0.22 2.2	0.27 2.7	0.33 3.3	0.36 3.6	0.46 4.6	0.55 5.5	0.66 6.6	0.66 6.6	0.82 8.2	0.98 9.8	1.18 11.8	1.31 13.1	1.48 14.8	1.77 17.7	2.21 22.1	2.66 26.6	2.95 29.5	3.54 35.4	4.43 44.3	5 50	5 50

#### ● Single-phase 200V/240V

unit = above : N·m / below : Kgf·cm

Model	Ratio	Speed(rpm)																								
		3	3.6	5	6	7.5	9	10	12.5	15	18	20	25	30	36	40	50	60	75	90	100	120	150	180	200	
K7I□15N□-SU K7G□B(C)	1200	200V/220V/ 230V/240V/ 50Hz	0.30 3.0	0.36 3.6	0.51 5.1	0.61 6.1	0.76 7.6	0.91 9.1	1.01 10.1	1.27 12.7	1.52 15.2	1.82 18.2	1.82 18.2	2.28 22.8	2.73 27.3	3.28 32.8	3.65 36.5	4.10 41.0	4.92 49.2	6.15 61.5	5 50	5 50	5 50	5 50	5 50	5 50
		200V/220V/ 230V/60Hz	0.26 2.6	0.31 3.1	0.43 4.3	0.51 5.1	0.64 6.4	0.77 7.7	0.85 8.5	1.06 10.6	1.28 12.8	1.53 15.3	1.53 15.3	1.91 19.1	2.30 23.0	2.76 27.6	3.06 30.6	3.44 34.4	4.13 41.3	5 50	5 50	5 50	5 50	5 50	5 50	5 50
	90	0.10 1.0	0.12 1.2	0.16 1.6	0.19 1.9	0.24 2.4	0.29 2.9	0.32 3.2	0.41 4.1	0.49 4.9	0.58 5.8	0.58 5.8	0.73 7.3	0.87 8.7	1.05 10.5	1.17 11.7	1.31 13.1	1.57 15.7	1.97 19.7	2.36 23.6	2.62 26.2	3.15 31.5	3.94 39.4	4.72 47.2	5 50	

- \* Gearhead and decimal gearhead are sold separately.
- \* The code in □ of gearhead model is for gear ratio.
- \* ■ color indicates that the output shaft of the geared motor rotates in the same direction as the output shaft of the motor. Others indicate rotation in the opposite direction.
- \* If you are to have less ratio than the ratio in the table, you can install the decimal gearhead, which has one tenth of the ratio, between the gearhead and the motor. In this case, the permissible torque is 5N·m/50kgf·cm.
- \* RPM is based on motor's synchronous rpm (50HZ:1500rpm, 60HZ:1800rpm) and calculated by dividing gear ratio. Actual rpm is 2~20% less than indicating rpm according to load size.

## GEARHEADS

### CONNECTION DIAGRAMS

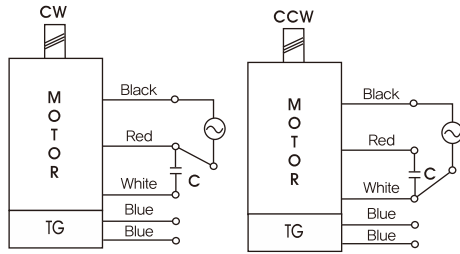

※The direction of motor rotation is as viewed from the front shaft end of the motor

### DIMENSIONS

K7G□B(C)



K7IG15N□-SU + K7G□B(C)

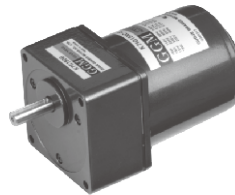

DECIMAL GEARHEAD

K7G10BX

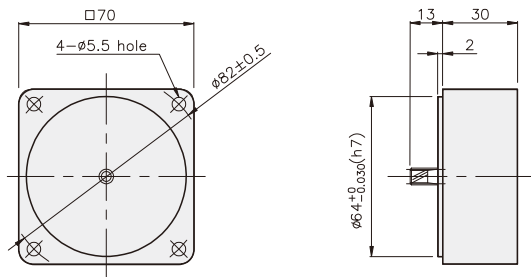

GEARHEAD

K7G□B(C)

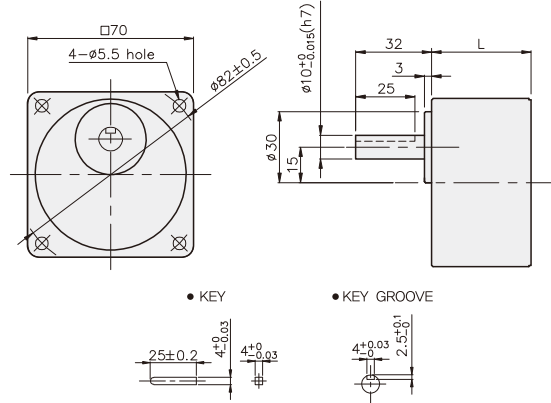

SPEED CONTROL MOTOR  
- SU SERIES

#### DIMENSION TABLE

PART No.	L	Application Model	Mounting BOLT
01	32	K7G3~18B(C)	M5 P0,8 X 50
02	40	K7G20~200B(C)	M5 P0,8 X 65
03	32	K7G10BX	M5 P0,8 X 90

#### WEIGHT

PART	WEIGHT(kg)	
MOTOR	1,16	
DECIMAL GEAR HEAD	0,32	
GEAR HEAD	K7G3~18B(C)	0,36
	K7G20~40B(C)	0,46
	K7G50~200B(C)	0,51

K7IG15N□-SU + K7G□B(C)

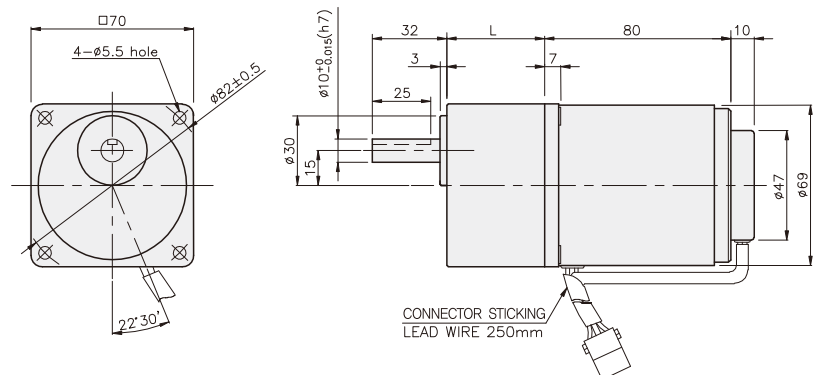

## SPEED CONTROL MOTOR - SU SERIES

### 25W

### □80mm

### INDUCTION MOTOR

K8IS25N□-SU

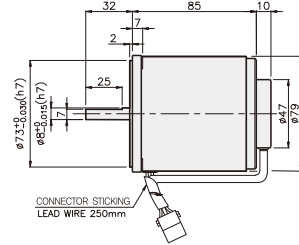
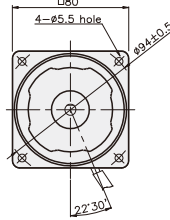
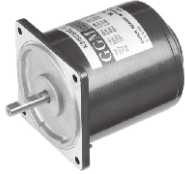

### SPECIFICATIONS

25W continuous rating, four poles

Model	Voltage (V)	Frequency (Hz)	Speed Range (rpm)	Permissible Torque		Start T. (N*m/Kgf*cm)	Current (A)	Condenser (μF)
				1200rpm (N*m/Kgf*cm)	90rpm (N*m/Kgf*cm)			
K8I□25NJ-SU	100	50	90 ~ 1400	0.2/2	0.05/0.5	0.08 0.8	0.8	7
			90 ~ 1700					
K8I□25NU-SU	110	60	90 ~ 1700	0.2/2	0.05/0.5	0.08 0.8	0.67	5
	115						0.68	
K8I□25NL-SU	200	50	90 ~ 1400	0.19/1.9	0.047/0.47	0.085 0.085	0.36	1.8
		60	90 ~ 1700	0.13/1.3	0.043/0.43		0.38	
K8I□25NC-SU	220	50	90 ~ 1400	0.19/1.9	0.047/0.47	0.08 0.8	0.38	1.5
		60	90 ~ 1700	0.13/1.3	0.043/0.43		0.35	
	230	50	90 ~ 1400	0.19/1.9	0.047/0.47	0.087 0.87	0.4	
		60	90 ~ 1700	0.13/1.3	0.043/0.43		0.36	
K8I□25ND-SU	240	50	90 ~ 1400	0.19/1.9	0.047/0.47	0.08 0.8	0.42	1.2

\* □ : SHAFT SHAPE (S : STRAIGHT, G : PINION)

### RATED TORQUE OF GEARHEAD

#### ● Single-phase 100V/115V

unit = above : N·m / below : Kgf·cm

Model	Ratio	Speed(rpm)																								
		3	3.6	5	6	7.5	9	10	12.5	15	18	20	25	30	36	40	50	60	75	90	100	120	150	180	200	250
K8I□25N□-SU K8G□B(C)	1200	0.46 4.9	0.58 5.8	0.81 8.1	0.97 9.7	1.22 12.2	1.46 14.6	1.62 16.2	2.03 20.3	2.43 24.3	2.92 29.2	3.65 36.5	4.37 43.7	5.25 52.5	5.83 58.3	6.56 65.6	7.87 78.7	8 80	8 80	8 80	8 80	8 80	8 80	8 80	8 80	8 80
	90	0.12 1.2	0.15 1.5	0.20 2.0	0.24 2.4	0.30 3.0	0.36 3.6	0.41 4.1	0.51 5.1	0.61 6.1	0.73 7.3	0.73 7.3	0.91 9.1	1.09 10.9	1.31 13.1	1.46 14.6	1.64 16.4	1.97 19.7	2.46 24.6	2.95 29.5	3.28 32.8	3.94 39.4	4.92 49.2	5.90 59.0	6.56 65.6	8 80

#### ● Single-phase 200V/240V

unit = above : N·m / below : Kgf·cm

Model	Ratio	Speed(rpm)																								
		3	3.6	5	6	7.5	9	10	12.5	15	18	20	25	30	36	40	50	60	75	90	100	120	150	180	200	250
K8I□25N□-SU K8G□B(C)	1200	200V/220V/230V 240V/50Hz	0.46 4.9	0.55 5.5	0.77 7.7	0.92 9.2	1.15 11.5	1.39 13.9	1.54 15.4	1.92 19.2	2.31 23.1	2.77 27.7	2.77 27.7	3.46 34.6	4.16 41.6	4.99 49.9	5.54 55.4	6.23 62.3	7.48 74.8	9.35 93.5	11.22 112.2	8 80	8 80	8 80	8 80	8 80
		200V/220V/230V 240V/60Hz	0.32 3.2	0.38 3.8	0.53 5.3	0.63 6.3	0.79 7.9	0.95 9.5	1.05 10.5	1.32 13.2	1.58 15.8	1.90 19.0	1.90 19.0	2.37 23.7	2.84 28.4	3.41 34.1	3.79 37.9	4.26 42.6	5.12 51.2	6.40 64.0	7.68 76.8	8 80	8 80	8 80	8 80	8 80
	90	200V/220V/230V 240V/50Hz	0.11 1.1	0.14 1.4	0.19 1.9	0.23 2.3	0.29 2.9	0.34 3.4	0.38 3.8	0.48 4.8	0.57 5.7	0.69 6.9	0.69 6.9	0.86 8.6	1.03 10.3	1.23 12.3	1.37 13.7	1.54 15.4	1.85 18.5	2.31 23.1	2.78 27.8	3.08 30.8	3.70 37.0	4.63 46.3	5.55 55.5	6.17 61.7
		200V/220V/230V 240V/60Hz	0.10 1.0	0.13 1.3	0.17 1.7	0.21 2.1	0.26 2.6	0.31 3.1	0.35 3.5	0.44 4.4	0.52 5.2	0.63 6.3	0.63 6.3	0.78 7.8	0.94 9.4	1.13 11.3	1.25 12.5	1.41 14.1	1.69 16.9	2.12 21.2	2.54 25.4	2.82 28.2	3.39 33.9	4.23 42.3	5.08 50.8	5.64 56.4

\* Gearhead and decimal gearhead are sold separately.

\* The code in □ of gearhead model is for gear ratio.

\* ■ color indicates that the output shaft of the geared motor rotates in the same direction as the output shaft of the motor. Others indicate rotation in the opposite direction.

\* If you are to have less ratio than the ratio in the table, you can install the decimal gearhead, which has one tenth of the ratio, between the gearhead and the motor. In this case, the permissible torque is 8N·m/80kgf·cm. But, if you install 1/25~1/40 gearhead, the permissible torque is 6N·m/60kgf·cm.

\* RPM is based on motor's synchronous rpm (50HZ:1500rpm, 60HZ:1800rpm) and calculated by dividing gear ratio. Actual rpm is 2~20% less than indicating rpm according to load size.



## GEARHEADS

### CONNECTION DIAGRAMS

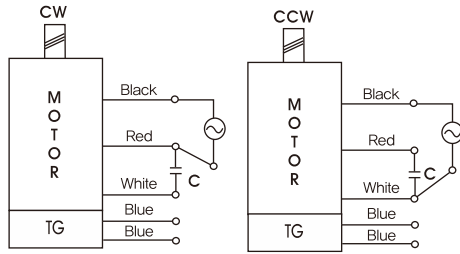

※The direction of motor rotation is as viewed from the front shaft end of the motor

### DIMENSIONS

K8G□B(C)



K8IG25N□-SU + K8G□B(C)



DECIMAL GEARHEAD  
K8G10BX

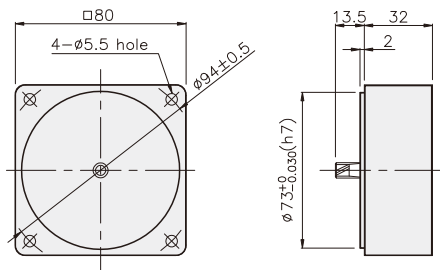

GEARHEAD  
K8G□B(C)

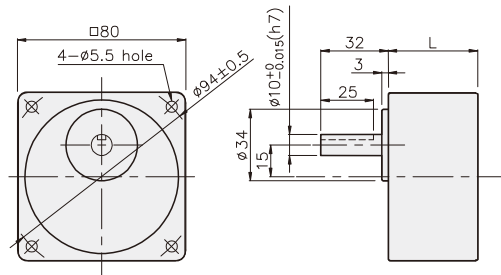

• KEY      • KEY GROOVE

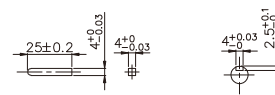

#### DIMENSION TABLE

PART No.	L	Application Model	Mounting BOLT
01	32	K8G3~18B(C)	M5 P0.8 X 50
02	42.5	K8G20~250B(C)	M5 P0.8 X 65
03	32	K8G10BX	M5 P0.8 X 95

#### WEIGHT

PART	WEIGHT(kg)	
MOTOR	1.60	
DECIMAL GEAR HEAD	0.46	
GEAR HEAD	K8G3~18B(C)	0.51
	K8G20~40B(C)	0.64
	K8G50~250B(C)	0.70

K8IG25N□-SU + K8G□B(C)

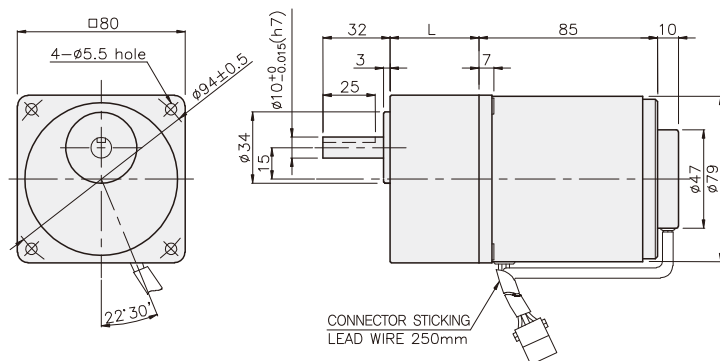

## SPEED CONTROL MOTOR - SU SERIES

**40W**

□90mm

**INDUCTION MOTOR**

**K9IS40N□-SU**

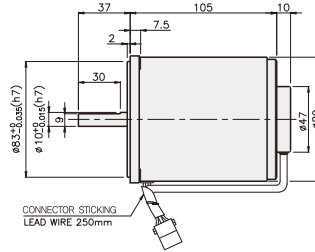
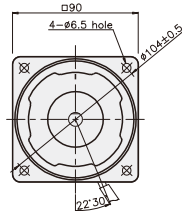
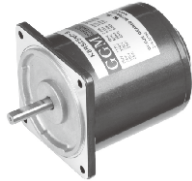

### SPECIFICATIONS

40W continuous rating, four poles

Model	Voltage (V)	Frequency (Hz)	Speed Range (rpm)	Permissible Torque		Start T. (N*m/Kgf*cm)	Current (A)	Condenser (μF)
				1200rpm (N*m/Kgf*cm)	90rpm (N*m/Kgf*cm)			
K9I□40NJ-SU	100	50	90 ~ 1400	0.26/2.6	0.07/0.7	0.14/1.4	1.3	12
		60	90 ~ 1700					
K9I□40NU-SU	110	60	90 ~ 1700	0.26/2.6	0.07/0.7	0.13/1.3	1.1	8
	115							
K9I□40NL-SU	200	50	90 ~ 1400	0.3/3	0.063/0.63	0.14/1.4	0.6	3
		60	90 ~ 1700	0.23/2.3			0.62	
K9I□40NC-SU	220	50	90 ~ 1400	0.3/3	0.063/0.63	0.14/1.4	0.58	2.5
		60	90 ~ 1700	0.23/2.3		0.13/1.3	0.62	
	230	50	90 ~ 1400	0.3/3		0.14/1.4	0.6	
		60	90 ~ 1700	0.23/2.3		0.13/1.3	0.62	
K9I□40ND-SU	240	50	90 ~ 1400	0.3/3	0.063/6.3	0.13/1.3	0.6	2

\* □ : SHAFT SHAPE (S : STRAIGHT, G : PINION)

### RATED TORQUE OF GEARHEAD

#### ● Single-phase 100V/115V

unit : above : N·m / below : Kgf·cm

Model	Ratio	3	3.6	5	6	7.5	9	10	12.5	15	18	20	25	30	36	40	50	60	75	90	100	120	150	180	200
Motor/Gearhead	Speed(rpm)																								
K9I□40N□-SU K9G□B(C)	1200	0.63 6.3	0.76 7.6	1.05 10.5	1.26 12.6	1.58 15.8	1.90 19.0	2.11 21.1	2.63 26.3	3.16 31.6	3.79 37.9	3.79 37.9	4.74 47.7	5.69 56.9	6.82 68.2	7.58 75.8	8.53 85.3	10 100	10 100	10 100	10 100	10 100	10 100	10 100	10 100
	90	0.17 1.7	0.20 2.0	0.28 2.8	0.34 3.4	0.43 4.3	0.51 5.1	0.57 5.7	0.71 7.1	0.85 8.5	1.02 10.2	1.02 10.2	1.28 12.8	1.53 15.3	1.84 18.4	2.04 20.4	2.30 23.0	2.76 27.6	3.44 34.4	4.13 41.3	4.59 45.9	5.51 55.1	6.89 68.9	8.27 82.7	9.19 91.9

#### ● Single-phase 200V/240V

unit : above : N·m / below : Kgf·cm

Model	Ratio	3	3.6	5	6	7.5	9	10	12.5	15	18	20	25	30	36	40	50	60	75	90	100	120	150	180	200
Motor/Gearhead	Speed(rpm)																								
K9I□40N□-SU K9G□B(C)	1200	200V/220V/ 230V/240V/50Hz	0.73 7.3	0.87 8.7	1.22 12.2	1.46 14.6	1.82 18.2	2.19 21.9	2.43 24.3	3.04 30.4	3.65 36.5	4.37 43.7	4.37 43.7	5.47 54.7	6.56 65.6	7.87 78.7	8.75 87.5	10 100	10 100	10 100	10 100	10 100	10 100	10 100	10 100
		200V/220V/ 230V/60Hz	0.56 5.6	0.67 6.7	0.93 9.3	1.12 11.2	1.40 14.0	1.68 16.8	1.86 18.6	2.33 23.3	2.79 27.9	3.35 33.5	3.35 33.5	4.19 41.9	5.03 50.3	6.04 60.4	6.71 67.1	8.38 83.8	10 100	10 100	10 100	10 100	10 100	10 100	10 100
	90	0.15 1.5	0.18 1.8	0.26 2.6	0.31 3.1	0.38 3.8	0.46 4.6	0.51 5.1	0.64 6.4	0.77 7.7	0.92 9.2	0.92 9.2	1.15 11.5	1.38 13.8	1.65 16.5	1.84 18.4	2.07 20.7	2.48 24.8	3.10 31.0	3.72 37.2	4.13 41.3	4.96 49.6	6.20 62.0	7.44 74.4	8.27 82.7

- \* Gearhead and decimal gearhead are sold separately.
- \* The code in □ of gearhead model is for gear ratio.
- \* ■ color indicates that the output shaft of the geared motor rotates in the same direction as the output shaft of the motor, Others indicate rotation in the opposite direction.
- \* If you are to have less ratio than the ratio in the table, you can install the decimal gearhead, which has one tenth of the ratio, between the gearhead and the motor. In this case, the permissible torque is 10N·m/100kgf·cm.
- \* RPM is based on motor's synchronous rpm (50HZ:1500rpm, 60HZ:1800rpm) and calculated by dividing gear ratio. Actual rpm is 2~20% less than indicating rpm according to load size.

## GEARHEADS

### CONNECTION DIAGRAMS

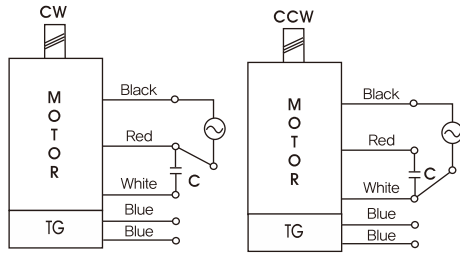

※The direction of motor rotation is as viewed from the front shaft end of the motor

### DIMENSIONS

K9G□B(C)

K9IG40N□-SU + K9G□B(C)



DECIMAL GEARHEAD  
K9G10BX

GEARHEAD  
K9G□B(C)

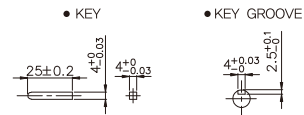
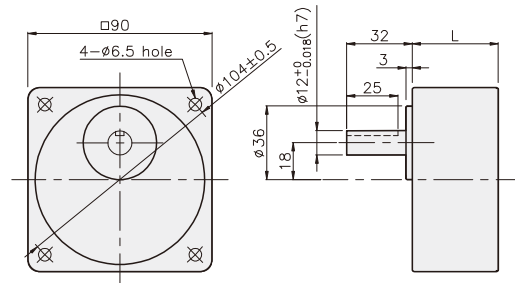
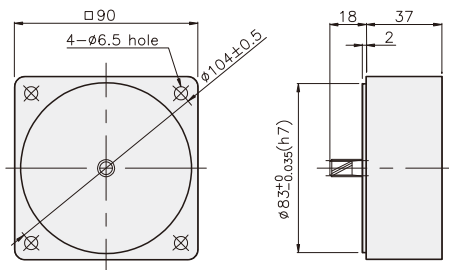

#### DIMENSION TABLE

PART No.	L	Application Model	Mounting BOLT
01	42	K9G3~18B(C)	M6 P1,0 X 65
02	60	K9G20~200B(C)	M6 P1,0 X 80
03	37	K9G10BX	M6 P1,0 X 120

#### WEIGHT

PART	WEIGHT(kg)	
MOTOR	2,48	
DECIMAL GEAR HEAD	0,60	
GEAR HEAD	K9G3~18B(C)	0,78
	K9G20~40B(C)	1,04
	K9G50~200B(C)	1,14

K9IG40N□-SU + K9G□B(C)

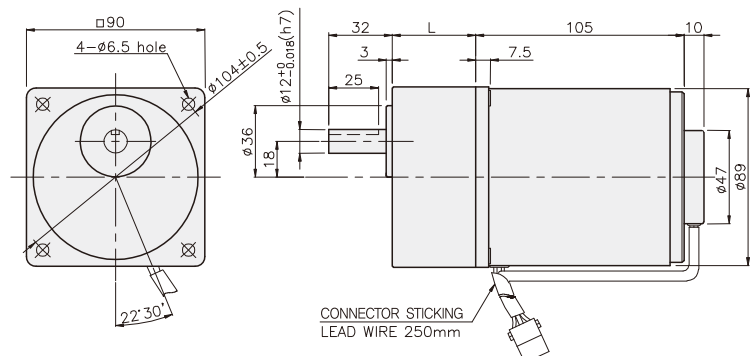

## SPEED CONTROL MOTOR - SU SERIES

### 60W

### □90mm

### INDUCTION MOTOR

K9IS60F□-SU

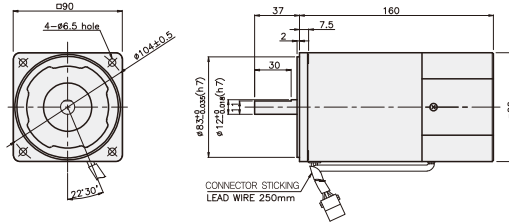
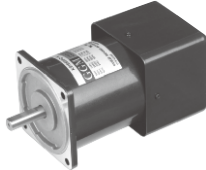

### SPECIFICATIONS

60W continuous rating, four poles

Model	Voltage (V)	Frequency (Hz)	Speed Range (rpm)	Permissible Torque		Start T. (N*m/Kgf*cm)	Current (A)	Condenser (μF)
				1200rpm (N*m/Kgf*cm)	90rpm (N*m/Kgf*cm)			
K9I□60FJ-SU	100	50	90 ~ 1400	0.45/4.5	0.15/1.5	0.24/2.4	2.3	20
			90 ~ 1700			0.21/2.1		
K9I□60FU-SU	110	60	90 ~ 1700	0.45/4.5	0.15/1.5	0.285/2.85	2	16
	115					2.1		
K9I□60FL-SU	200	50	90 ~ 1400	0.49/4.9	0.14/1.4	0.24/2.4	1.2	5
		60	90 ~ 1700	0.45/4.5	0.16/1.6	0.21/2.1		
K9I□60FC-SU	220	50	90 ~ 1400	0.49/4.9	0.14/1.4	0.24/2.4	0.91	4
		60	90 ~ 1700	0.45/4.5	0.16/1.6	0.21/2.1	0.9	
	230	50	90 ~ 1400	0.49/4.9	0.14/1.4	0.24/2.4	1	
		60	90 ~ 1700	0.45/4.5	0.16/1.6	0.24/2.4		
K9I□60FD-SU	240	50	90 ~ 1400	0.49/4.9	0.14/1.4	0.28/2.8	1.1	4

※ □ : SHAFT SHAPE ( S : STRAIGHT, P : PINION )

### RATED TORQUE OF GEARHEAD

#### ● Single-phase 100V/115V

unit = above : N·m / below : Kgf·cm

Model	Ratio	Speed(rpm)																							
		3	3.6	5	6	7.5	9	10	12.5	15	18	20	25	30	36	40	50	60	75	90	100	120	150	180	200
K9I□60F□-SU K9P□B, BF	1200	1.09 10.9	1.31 13.1	1.82 18.2	2.19 21.9	2.73 27.3	3.28 32.8	3.65 36.5	4.10 41.0	4.92 49.2	5.90 59.0	6.56 65.6	7.38 73.8	8.86 88.6	10.63 106.3	11.81 118.1	14.76 147.6	17.71 177.1	20 200	20 200	20 200	20 200	20 200	20 200	20 200
	90	0.36 3.6	0.44 4.4	0.61 6.1	0.73 7.3	0.91 9.1	1.09 10.9	1.22 12.2	1.37 13.7	1.64 16.4	1.97 19.7	2.19 21.9	2.46 24.6	2.95 29.5	3.54 35.4	3.94 39.4	4.92 49.2	5.90 59.0	6.64 66.4	7.97 79.7	8.86 88.6	10.63 106.3	13.29 132.9	15.94 159.4	17.71 177.1

#### ● Single-phase 200V/240V

unit = above : N·m / below : Kgf·cm

Model	Ratio	Speed(rpm)																								
		3	3.6	5	6	7.5	9	10	12.5	15	18	20	25	30	36	40	50	60	75	90	100	120	150	180	200	
K9I□60F□-SU K9P□B, BF	1200	200V/220V/230V 240V/50Hz	1.19 11.9	1.43 14.3	1.98 19.8	2.38 23.8	2.98 29.8	3.57 35.7	3.97 39.7	4.47 44.7	5.36 53.6	6.43 64.3	7.14 71.4	8.04 80.4	9.64 96.4	11.57 115.7	12.86 128.6	16.07 160.7	19.29 192.9	20 200	20 200	20 200	20 200	20 200	20 200	
		200V/220V 230V/60Hz	1.09 10.9	1.31 13.1	1.82 18.2	2.19 21.9	2.73 27.3	3.28 32.8	3.65 36.5	4.10 41.0	4.92 49.2	5.90 59.0	6.56 65.6	7.38 73.8	8.86 88.6	10.63 106.3	11.81 118.1	14.76 147.6	17.71 177.1	20 200	20 200	20 200	20 200	20 200	20 200	
	90	200V/220V/230V 240V/50Hz	0.34 3.4	0.41 4.1	0.57 5.7	0.68 6.8	0.85 8.5	1.02 10.2	1.13 11.3	1.28 12.8	1.53 15.3	1.84 18.4	2.04 20.4	2.30 23.0	2.76 27.6	3.31 33.1	3.67 36.7	4.59 45.9	5.51 55.1	6.20 62.0	7.44 74.4	8.27 82.7	9.92 99.2	12.40 124.0	14.88 148.8	16.53 165.3
		200V/220V 230V/60Hz	0.39 3.9	0.47 4.7	0.65 6.5	0.78 7.8	0.97 9.7	1.17 11.7	1.30 13.0	1.46 14.6	1.75 17.5	2.10 21.0	2.33 23.3	2.62 26.2	3.15 31.5	3.78 37.8	4.20 42.0	5.25 52.5	6.30 63.0	7.09 70.9	8.50 85.0	9.45 94.5	11.34 113.4	14.17 141.7	17.01 170.1	18.90 189.0

- \* Gearhead and decimal gearhead are sold separately.
- \* The code in □ of gearhead model is for gear ratio.
- \* ■ color indicates that the output shaft of the geared motor rotates in the same direction as the output shaft of the motor. Others indicate rotation in the opposite direction.
- \* If you are to have less ratio than the ratio in the table, you can install the decimal gearhead, which has one tenth of the ratio, between the gearhead and the motor. In this case, the permissible torque is 20N·m/200kgf·cm.
- \* RPM is based on motor's synchronous rpm (50HZ:1500rpm, 60HZ:1800rpm) and calculated by dividing gear ratio. Actual rpm is 2~20% less than indicating rpm according to load size.

## GEARHEADS

### CONNECTION DIAGRAMS

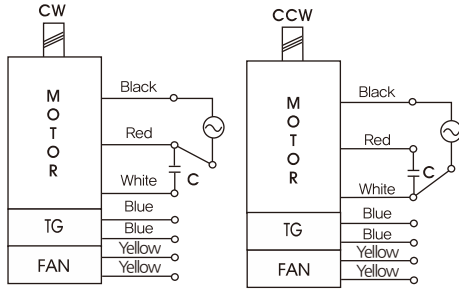

※The direction of motor rotation is as viewed from the front shaft end of the motor

### DIMENSIONS

K9P□B



K9P□BF



### DECIMAL GEARHEAD

K9P10BX

### KEY SPEC

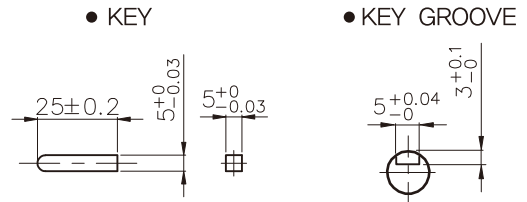
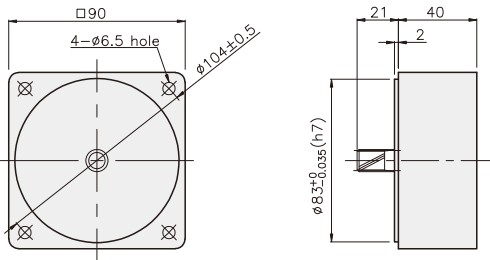

### GEARHEAD

K9P□B

K9P□BF

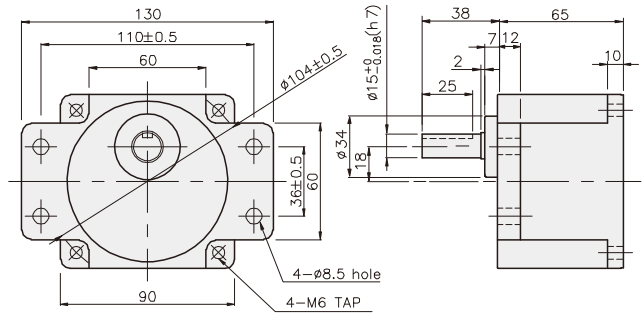
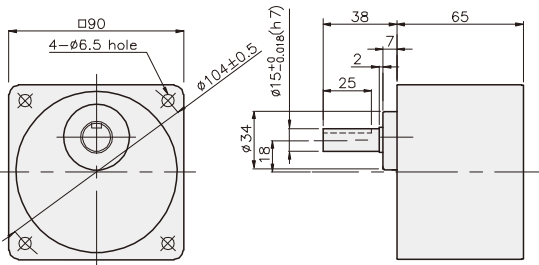

## GEARHEADS

### DIMENSIONS

K9IP60F□-SU + K9P□B

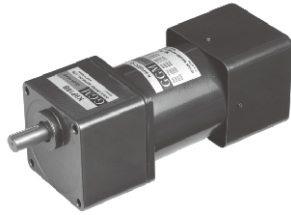

K9IP60F□-SU + K9P□BF

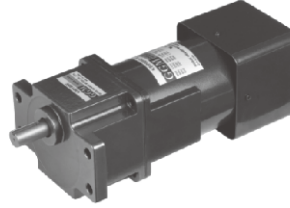

K9IP60F□-SU + K9P□B

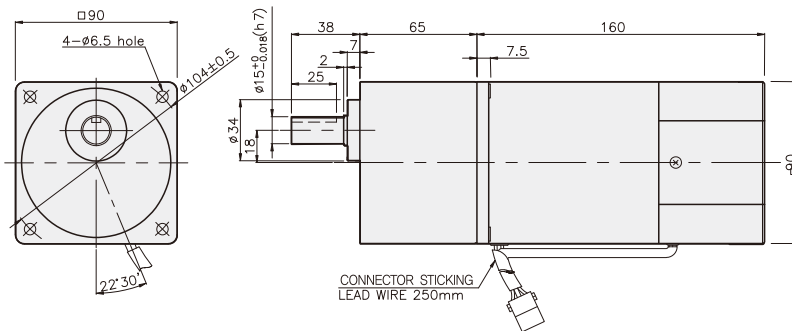

#### DIMENSION TABLE

PART No.	L	Application Model	Mounting BOLT
01	65	K9P3~200B	M6 P1,0 X 95
02	40	K9P10BX	M6 P1,0 X 140

#### WEIGHT

PART	WEIGHT(kg)	
MOTOR	3,06	
DECIMAL GEAR HEAD	0,62	
GEAR HEAD	K9P3~10B	1,22
	K9P12,5~20B	1,32
	K9P25~60B	1,42
	K9P75~200B	1,45

K9IP60F□-SU + K9P□BF

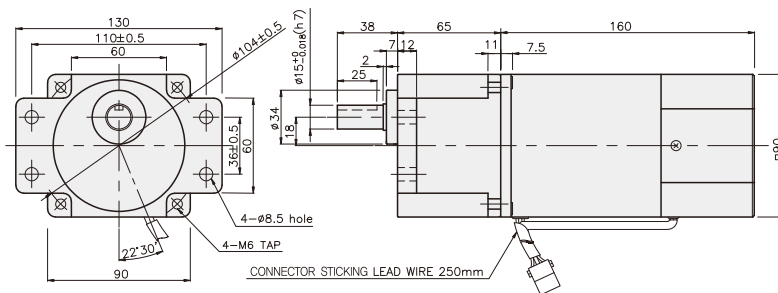

#### DIMENSION TABLE

PART No.	L	Application Model	Mounting BOLT
01	65	K9P3~200BF	M6 P1,0 X 25
02	40	K9P10BX	M6 P1,0 X 65

#### WEIGHT

PART	WEIGHT(kg)	
MOTOR	3,58	
DECIMAL GEAR HEAD	0,62	
GEAR HEAD	K9P3~10BF	1,22
	K9P12,5~20BF	1,30
	K9P25~60BF	1,42
	K9P75~200BF	1,44



## SPEED CONTROL MOTOR - SU SERIES

**90W**

**□90mm**

**INDUCTION MOTOR**

**K9IS90F□-SU**

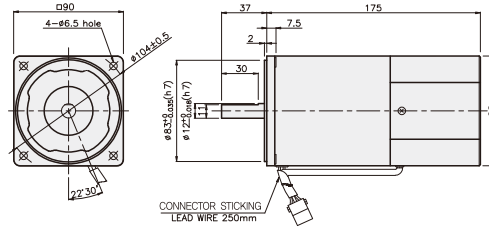
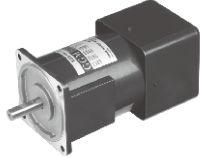

### SPECIFICATIONS

90W continuous rating, four poles

Model	Voltage (V)	Frequency (Hz)	Speed Range (rpm)	Permissible Torque		Start T. (N*m/Kgf*cm)	Current (A)	Condenser (μF)
				1200rpm (N*m/Kgf*cm)	90rpm (N*m/Kgf*cm)			
K9I□90FJ-SU	100	50	90 ~ 1400	0.7/7	0.23/2.3	0.36/3.6	3.2	30
			90 ~ 1700					
K9I□90FU-SU	110	60	90 ~ 1700	0.7/7	0.23/2.3	0.35/3.5	2.6	20
	115							
K9I□90FL-SU	200	50	90 ~ 1400	0.73/7.3	0.23/2.3	0.36/3.6	1.3	7
			90 ~ 1700		0.26/2.6			
K9I□90FC-SU	220	50	90 ~ 1400	0.73/7.3	0.23/2.3	0.36/3.6	1.1	6
			90 ~ 1700		0.26/2.6			
	230	50	90 ~ 1400		0.23/2.3	0.4/4	1.2	
			90 ~ 1700		0.26/2.6			
K9I□90FD-SU	240	50	90 ~ 1400	0.73/7.3	0.23/2.3	0.36/3.6	1.2	5

※ □ : SHAFT SHAPE ( S : STRAIGHT, P : PINION )

### RATED TORQUE OF GEARHEAD

● Single-phase 100V/115V

unit = above : N·m / below : Kgf·cm

Model	Ratio	3	3.6	5	6	7.5	9	10	12.5	15	18	20	25	30	36	40	50	60	75	90	100	120	150	180	200
K9I□90F□-SU K9P□B, BF	1200	1.70 17.0	2.04 20.4	2.84 28.4	3.40 34.0	4.25 42.5	5.10 51.0	5.67 56.7	6.38 63.8	7.65 76.5	9.19 91.9	10.21 102.1	11.48 114.8	13.78 137.8	16.53 165.3	18.37 183.7	20 200	20 200	20 200	20 200	20 200	20 200	20 200	20 200	20 200
	90	0.56 5.6	0.67 6.7	0.93 9.3	1.12 11.2	1.40 14.0	1.68 16.8	1.86 18.6	2.10 21.0	2.52 25.2	3.02 30.2	3.35 33.5	3.77 37.7	4.53 45.3	5.43 54.3	6.04 60.4	7.55 75.5	9.05 90.5	10.19 101.9	12.22 122.2	13.58 135.8	16.30 163.0	20 200	20 200	20 200

● Single-phase 200V/240V

unit = above : N·m / below : Kgf·cm

Model	Ratio	3	3.6	5	6	7.5	9	10	12.5	15	18	20	25	30	36	40	50	60	75	90	100	120	150	180	200	
K9I□90F□-SU K9P□B, BF	1200	1.77 17.7	2.13 21.3	2.96 29.6	3.55 35.5	4.43 44.3	5.32 53.2	5.91 59.1	6.65 66.5	7.98 79.8	9.58 95.8	10.64 106.4	11.97 119.7	14.37 143.7	17.24 172.4	19.16 191.6	20 200	20 200	20 200	20 200	20 200	20 200	20 200	20 200	20 200	
	90	200V/220V/ 230V/240V/50Hz	0.56 5.6	0.67 6.7	0.93 9.3	1.12 11.2	1.40 14.0	1.68 16.8	1.86 18.6	2.10 21.0	2.52 25.2	3.02 30.2	3.35 33.5	3.77 37.7	4.53 45.3	5.43 54.3	6.04 60.4	7.55 75.5	9.05 90.5	10.19 101.9	12.22 122.2	13.58 135.8	16.30 163.0	20 200	20 200	20 200
		200V/220V/ 230V/60Hz	0.63 6.3	0.76 7.6	1.05 10.5	1.26 12.6	1.58 15.8	1.90 19.0	2.11 21.1	2.37 23.7	2.84 28.4	3.41 34.1	3.79 37.9	4.26 42.6	5.12 51.2	6.14 61.4	6.82 68.2	8.53 85.3	10.24 102.4	11.51 115.1	13.82 138.2	15.35 153.5	18.42 184.2	20 200	20 200	20 200

- \* Gearhead and decimal gearhead are sold separately.
- \* The code in □ of gearhead model is for gear ratio.
- \*  color indicates that the output shaft of the geared motor rotates in the same direction as the output shaft of the motor. Others indicate rotation in the opposite direction.
- \* If you are to have less ratio than the ratio in the table, you can install the decimal gearhead, which has one tenth of the ratio, between the gearhead and the motor. In this case, the permissible torque is 20N·m/200kgf·cm.
- \* RPM is based on motor's synchronous rpm (50HZ:1500rpm, 60HZ:1800rpm) and calculated by dividing gear ratio. Actual rpm is 2~20% less than indicating rpm according to load size.

SPEED CONTROL MOTOR - SU SERIES

## GEARHEADS

### RATED TORQUE OF GEARHEAD

#### ● Single-phase 100V/115V

unit = above : N·m / below : Kgf·cm

Model	Ratio																								
		3	3.6	5	6	7.5	9	10	12.5	15	18	20	25	30	36	40	50	60	75	90	100	120	150	180	200
Motor/Gearhead	Speed(rpm)																								
K9I□90F□-SU K9P□BU, BUF	1200	1.70 17.0	2.04 20.4	2.84 28.4	3.40 34.0	4.25 42.5	5.10 51.0	5.67 56.7	6.38 63.8	7.65 76.5	9.19 91.9	10.21 102.1	11.48 114.8	13.78 137.8	16.53 165.3	18.37 183.7	22.96 229.6	27.56 275.6	30 300	30 300	30 300	30 300	30 300	30 300	30 300
	90	0.56 5.6	0.67 6.7	0.93 9.3	1.12 11.2	1.40 14.0	1.68 16.8	1.86 18.6	2.10 21.0	2.52 25.2	3.02 30.2	3.35 33.5	3.77 37.7	4.53 45.3	5.43 54.3	6.04 60.4	7.55 75.5	9.05 90.5	10.19 101.9	12.22 122.2	13.58 135.8	16.30 163.0	20.37 203.7	24.45 244.5	27.16 271.6

#### ● Single-phase 200V/240V

unit = above : N·m / below : Kgf·cm

Model	Ratio																									
		3	3.6	5	6	7.5	9	10	12.5	15	18	20	25	30	36	40	50	60	75	90	100	120	150	180	200	
Motor/Gearhead	Speed(rpm)																									
K9I□90F□-SU K9P□BU, BUF	1200	1.77 17.7	2.13 21.3	2.96 29.6	3.55 35.5	4.43 44.3	5.32 53.2	5.91 59.1	6.65 66.5	7.98 79.8	9.58 95.8	10.64 106.4	11.97 119.7	14.37 143.7	17.24 172.4	19.16 191.6	23.95 239.5	28.74 287.4	30 300	30 300	30 300	30 300	30 300	30 300	30 300	
	90	200V/220V/ 230V/240V/ 50Hz	0.56 5.6	0.67 6.7	0.93 9.3	1.12 11.2	1.40 14.0	1.68 16.8	1.86 18.6	2.10 21.0	2.52 25.2	3.02 30.2	3.35 33.5	3.77 37.7	4.53 45.3	5.43 54.3	6.04 60.4	7.55 75.5	9.05 90.5	10.19 101.9	12.22 122.2	13.58 135.8	16.30 163.0	20.37 203.7	24.45 244.5	27.16 271.6
		200V/220V/ 230V/60Hz	0.63 6.3	0.76 7.6	1.05 10.5	1.26 12.6	1.58 15.8	1.90 19.0	2.11 21.1	2.37 23.7	2.84 28.4	3.41 34.1	3.79 37.9	4.26 42.6	5.12 51.2	6.14 61.4	6.82 68.2	8.53 85.3	10.24 102.4	11.51 115.1	13.82 138.2	15.35 153.5	18.42 184.2	23.03 230.3	27.63 276.3	30 300

- \* Gearhead and decimal gearhead are sold separately.
- \* The code in □ of gearhead model is for gear ratio.
- \* ■ color indicates that the output shaft of the geared motor rotates in the same direction as the output shaft of the motor. Others indicate rotation in the opposite direction.
- \* If you are to have less ratio than the ratio in the table, you can install the decimal gearhead, which has one tenth of the ratio, between the gearhead and the motor. In this case, the permissible torque is 30N·m/300kgf·cm.
- \* RPM is based on motor's synchronous rpm (50HZ:1500rpm, 60HZ:1800rpm) and calculated by dividing gear ratio. Actual rpm is 2~20% less than indicating rpm according to load size.

### CONNECTION DIAGRAMS

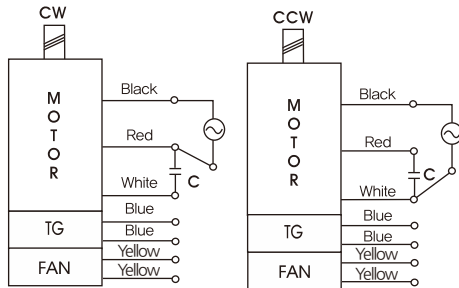

※The direction of motor rotation is as viewed from the front shaft end of the motor

## GEARHEADS

### DIMENSIONS

K9P□B



K9P□BF, BUF

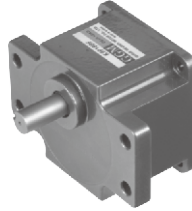

K9P□BU

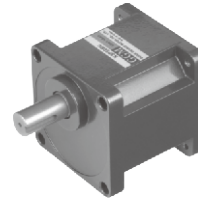

### DECIMAL GEARHEAD

K9P10BX

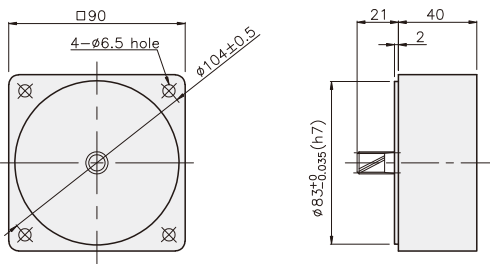

### KEY SPEC

● KEY

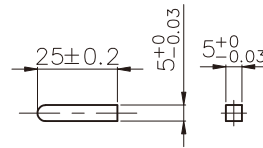

● KEY GROOVE

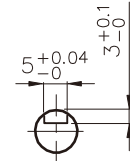

### GEARHEAD

K9P□B

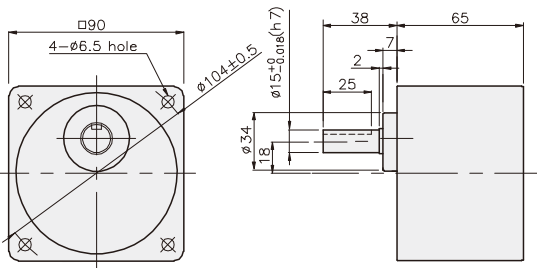

K9P□BF

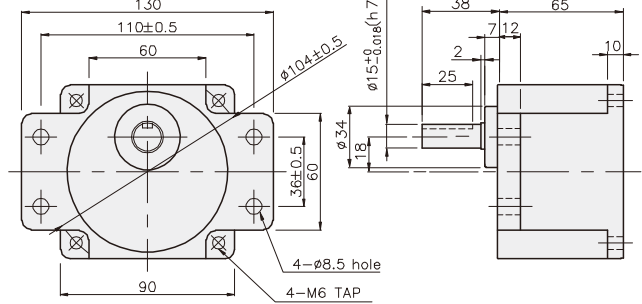

K9P□BU

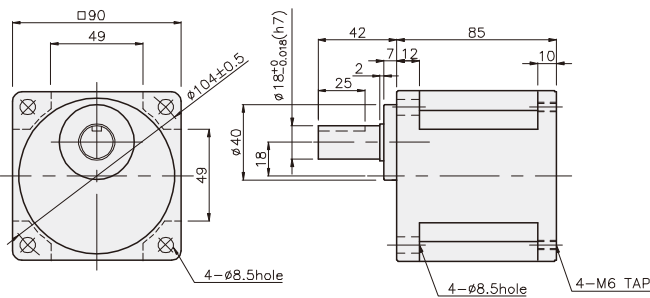

K9P□BUF

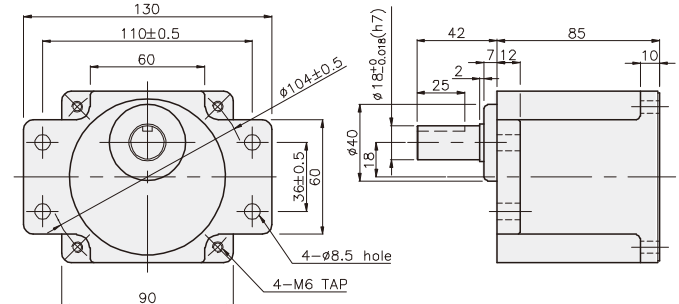

## GEARHEADS

### DIMENSIONS

K9IP90F□-SU + K9P□B



K9IP90F□-SU + K9P□BF, BUF

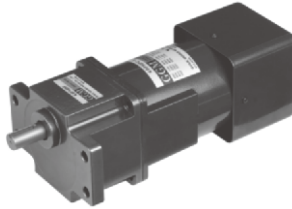

K9IP90F□-SU + K9P□BU

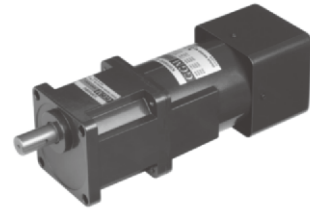

K9IP90F□-SU + K9P□B

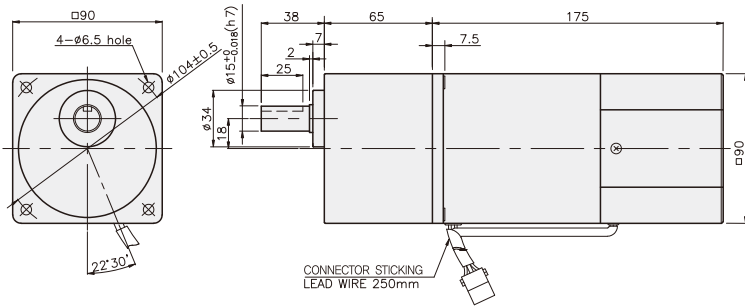

#### WEIGHT

PART	WEIGHT(kg)
MOTOR	3,06
DECIMAL GEAR HEAD	0,62

#### DIMENSION TABLE

PART No.	L	Application Model	Mounting BOLT
01	65	K9P3~200B	M6 P1,0 X 95
02	40	K9P10BX	M6 P1,0 X 140

#### WEIGHT

PART	WEIGHT(kg)
K9P3~10B	1,22
K9P12,5~20B	1,32
K9P25~60B	1,42
K9P75~200B	1,45

K9IP90F□-SU + K9P□BF

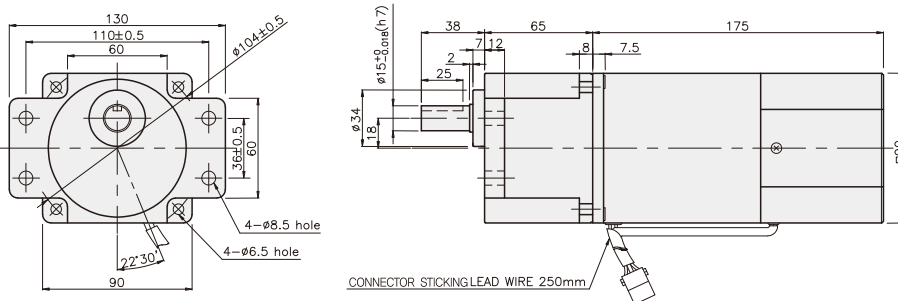

#### DIMENSION TABLE

PART No.	L	Application Model	Mounting BOLT
01	65	K9P3~200BF	M6 P1,0 X 25
02	40	K9P10BX	M6 P1,0 X 65

#### WEIGHT

PART	WEIGHT(kg)
K9P3~10BF	1,22
K9P12,5~20BF	1,30
K9P25~60BF	1,42
K9P75~200BF	1,44

K9IP90F□-SU + K9P□BU

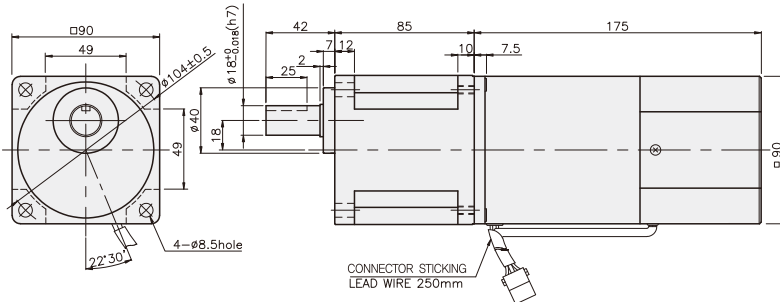

#### DIMENSION TABLE

PART No.	L	Application Model	Mounting BOLT
01	85	K9P3~200BU	M6 P1,0 X 20
02	40	K9P10BX	M6 P1,0 X 60

#### WEIGHT

PART	WEIGHT(kg)
K9P3~10BU	1,44
K9P12,5~20BU	1,55
K9P25~60BU	1,69
K9P75~200BU	1,74

K9IP90F□-SU + K9P□BUF

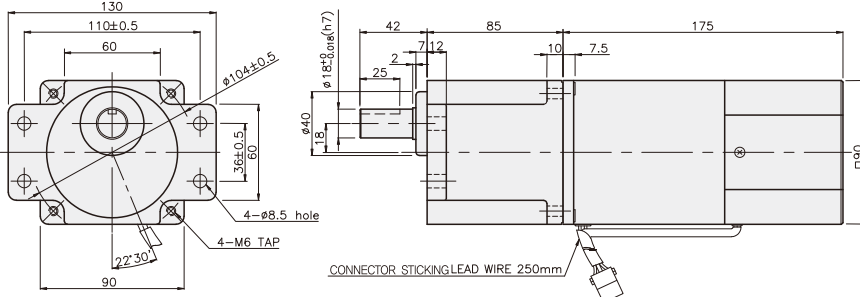

#### DIMENSION TABLE

PART No.	L	Application Model	Mounting BOLT
01	85	K9P3~200BUF	M6 P1,0 X 20
02	40	K9P10BX	M6 P1,0 X 65

#### WEIGHT

PART	WEIGHT(kg)
K9P3~10BUF	1,50
K9P12,5~20BUF	1,62
K9P25~60BUF	1,76
K9P75~200BUF	1,82

## SPEED CONTROL MOTOR - SU SERIES

### 120W

### □90mm

### INDUCTION MOTOR

K9IS120F□-SU

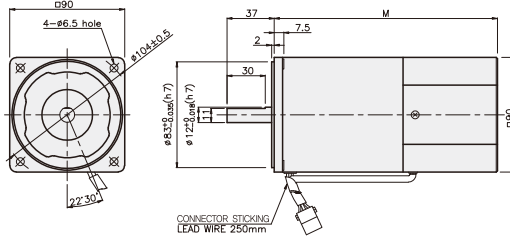
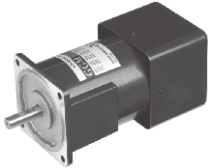

DIMENSION TABLE

PART No	M	Application Model
01	195	50Hz
02	175	60Hz

※ 50Hz motor is "C50" added to model number.

### SPECIFICATIONS

120W continuous rating, four poles

Model	Voltage (V)	Frequency (Hz)	Speed Range (rpm)	Permissible Torque		Start T. (N*m/Kgf*cm)	Current (A)	Condenser (μF)
				1200rpm (N*m/Kgf*cm)	90rpm (N*m/Kgf*cm)			
K9I□120FJ-SU	100	50	90 ~ 1400	0.83/8.3	0.3/3	0.4/4	3.4	35
			90 ~ 1700					
K9I□120FU-SU	110	60	90 ~ 1700	0.83/8.3	0.3/3	0.45/4.5	3.2	30
	115							
K9I□120FL-SU	200	50	90 ~ 1400	0.83/8.3	0.28/2.8	0.4/4	1.4	8.5
			90 ~ 1700					
K9I□120FC-SU	220	50	90 ~ 1400	0.83/8.3	0.28/2.8	0.4/4	1.2	6
			90 ~ 1700					
	230	60	90 ~ 1400	0.8/8	0.3/3	0.45/4.5	1.4	7
			90 ~ 1700					
K9I□120FD-SU	240	50	90 ~ 1400	0.83/8.3	0.28/2.8	0.4/4	1.3	6

※ □ : SHAFT SHAPE ( S : STRAIGHT, P : PINION )

### RATED TORQUE OF GEARHEAD

#### ● Single-phase 100V/115V

unit = above : N·m / below : Kgf·cm

Motor/Gearhead	Ratio Speed(rpm)	Ratio																							
		3	3.6	5	6	7.5	9	10	12.5	15	18	20	25	30	36	40	50	60	75	90	100	120	150	180	200
K9I□120F□-SU K9P□B, BF	1200	2.02	2.42	3.36	4.03	5.04	6.05	6.72	7.56	9.08	10.89	12.10	13.61	16.34	19.60	20	20	20	20	20	20	20	20	20	20
	90	0.73	0.87	1.22	1.46	1.82	2.19	2.43	2.73	3.28	3.94	4.37	4.92	5.90	7.09	7.87	9.84	11.81	13.29	15.94	17.71	20	20	20	20

#### ● Single-phase 200V/240V

unit = above : N·m / below : Kgf·cm

Model	Ratio Speed(rpm)	Ratio																							
		3	3.6	5	6	7.5	9	10	12.5	15	18	20	25	30	36	40	50	60	75	90	100	120	150	180	200
K9I□120F□-SU K9P□B, BF	1200	200V/220V/230V 240V/50Hz	2.02	2.42	3.36	4.03	5.04	6.05	6.72	7.56	9.08	10.89	12.10	13.61	16.34	19.60	20	20	20	20	20	20	20	20	20
		200V/220V 230V/60Hz	1.94	2.33	3.24	3.89	4.86	5.83	6.48	7.29	8.75	10.50	11.66	13.12	15.75	18.90	20	20	20	20	20	20	20	20	20
	90	200V/220V/230V 240V/50Hz	0.68	0.82	1.13	1.36	1.70	2.04	2.27	2.55	3.06	3.67	4.08	4.59	5.51	6.61	7.35	9.19	11.02	12.40	14.88	16.53	19.84	20	20
		200V/220V 230V/50Hz	0.73	0.87	1.22	1.46	1.82	2.19	2.43	2.73	3.28	3.94	4.37	4.92	5.90	7.09	7.87	9.84	11.81	13.29	15.94	17.71	20	20	20

- \* Gearhead and decimal gearhead are sold separately.
- \* The code in □ of gearhead model is for gear ratio.
- \*      color indicates that the output shaft of the geared motor rotates in the same direction as the output shaft of the motor. Others indicate rotation in the opposite direction.
- \* If you are to have less ratio than the ratio in the table, you can install the decimal gearhead, which has one tenth of the ratio, between the gearhead and the motor. In this case, the permissible torque is 20N·m/200kgf·cm.
- \* RPM is based on motor's synchronous rpm (50Hz:1500rpm, 60Hz:1800rpm) and calculated by dividing gear ratio. Actual rpm is 2~20% less than indicating rpm according to load size.

SPEED CONTROL MOTOR - SU SERIES

## GEARHEADS

### RATED TORQUE OF GEARHEAD

#### ● Single-phase 100V/115V

unit = above : N·m / below : Kgf·cm

Model	Ratio																								
		3	3,6	5	6	7,5	9	10	12,5	15	18	20	25	30	36	40	50	60	75	90	100	120	150	180	200
K9I□120F□-SU	1200	2.02 20,2	2.42 24,2	3.36 33,6	4.03 40,3	5.04 50,4	6.05 60,5	6.72 67,2	7.56 75,6	9.08 90,8	10.89 108,9	12.10 121,0	13.61 136,1	16.34 163,4	19.60 196,0	21.78 217,8	27.23 272,3	30 300	30 300	30 300	30 300	30 300	30 300	30 300	30 300
K9P□BU, BUF	90	0.73 7,3	0.87 8,7	1.22 12,2	1.46 14,6	1.82 18,2	2.19 21,9	2.43 24,3	2.73 27,3	3.28 32,8	3.94 39,4	4.37 43,7	4.92 49,2	5.90 59,0	7.09 70,9	7.87 78,7	9.84 98,4	11.81 118,1	13.29 132,9	15.94 159,4	17.71 177,1	21.26 212,6	26.57 265,7	30 300	30 300

#### ● Single-phase 200V/240V

unit = above : N·m / below : Kgf·cm

Model	Ratio																									
		3	3,6	5	6	7,5	9	10	12,5	15	18	20	25	30	36	40	50	60	75	90	100	120	150	180	200	
K9I□120F□-SU	1200	200V/220V/230V 240V/50HZ	2.02 20,2	2.42 24,2	3.36 33,6	4.03 40,3	5.04 50,4	6.05 60,5	6.72 67,2	7.56 75,6	9.08 90,8	10.89 108,9	12.10 121,0	13.61 136,1	16.34 163,4	19.60 196,0	21.78 217,8	27.23 272,3	30 300	30 300	30 300	30 300	30 300	30 300	30 300	
		200V/220V 230V/60HZ	1.94 19,4	2.33 23,3	3.24 32,4	3.89 38,9	4.86 48,6	5.83 58,3	6.48 64,8	7.29 72,9	8.75 87,5	10.50 105,0	11.66 116,6	13.12 131,2	15.75 157,5	18.90 189,0	21.00 210,0	26.24 262,4	30 300	30 300	30 300	30 300	30 300	30 300	30 300	30 300
K9P□BU, BUF	90	200V/220V/230V 240V/50HZ	0.68 6,8	0.82 8,2	1.13 11,3	1.36 13,6	1.70 17,0	2.04 20,4	2.27 22,7	2.55 25,5	3.06 30,6	3.67 36,7	4.08 40,8	4.59 45,9	5.51 55,1	6.61 66,1	7.35 73,5	9.19 91,9	11.02 110,2	12.40 124,0	14.88 148,8	16.53 165,3	19.84 198,4	24.80 248,0	29.76 297,6	30 300
		200V/220V 230V/60HZ	0.73 7,3	0.87 8,7	1.22 12,2	1.46 14,6	1.82 18,2	2.19 21,9	2.43 24,3	2.73 27,3	3.28 32,8	3.94 39,4	4.37 43,7	4.92 49,2	5.90 59,0	7.09 70,9	7.87 78,7	9.84 98,4	11.81 118,1	13.29 132,9	15.94 159,4	17.71 177,1	21.26 212,6	26.57 265,7	30 300	30 300

- \* Gearhead and decimal gearhead are sold separately.
- \* The code in □ of gearhead model is for gear ratio.
- \*   color indicates that the output shaft of the geared motor rotates in the same direction as the output shaft of the motor. Others indicate rotation in the opposite direction.
- \* If you are to have less ratio than the ratio in the table, you can install the decimal gearhead, which has one tenth of the ratio, between the gearhead and the motor. In this case, the permissible torque is 30N·m/300kgf·cm.
- \* RPM is based on motor's synchronous rpm (50HZ:1500rpm, 60HZ:1800rpm) and calculated by dividing gear ratio. Actual rpm is 2~20% less than indicating rpm according to load size.

### CONNECTION DIAGRAMS

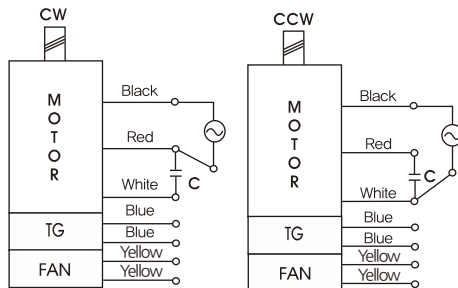

※The direction of motor rotation is as viewed from the front shaft end of the motor



## GEARHEADS

### DIMENSIONS

K9P□B



K9P□BF, BUF

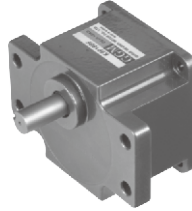

K9P□BU

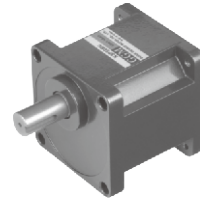

DECIMAL GEARHEAD  
K9P10BX

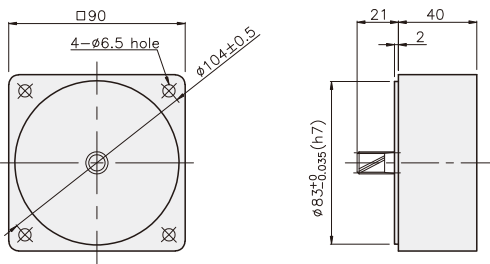

KEY SPEC

● KEY

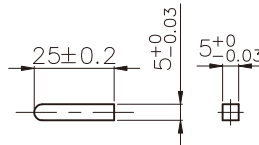

● KEY GROOVE

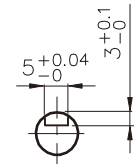

### GEARHEAD

K9P□B

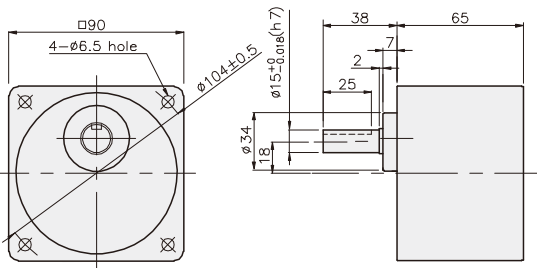

K9P□BF

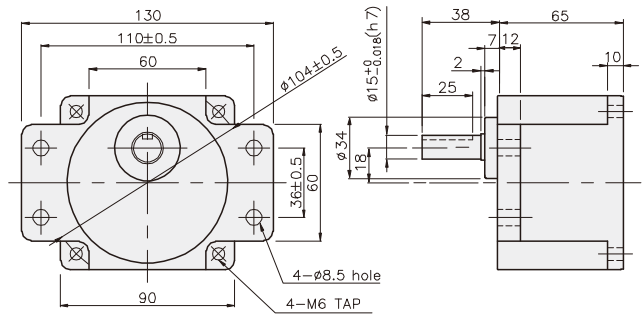

K9P□BU

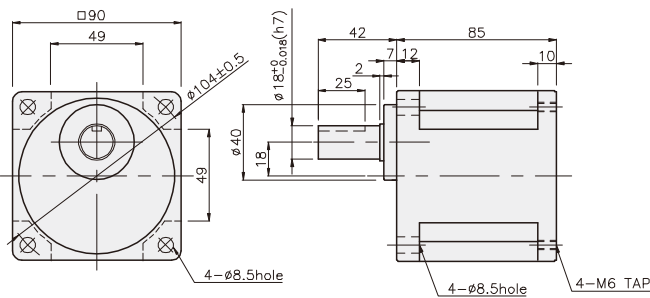

K9P□BUF

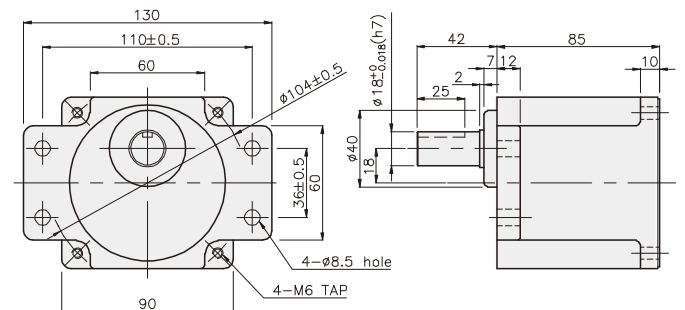

## GEARHEADS

### DIMENSIONS

K9IP120F□-SU + K9P□B



K9IP120F□-SU + K9P□BF, BUF

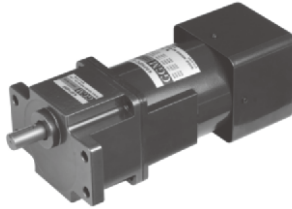

K9IP120F□-SU + K9P□BU

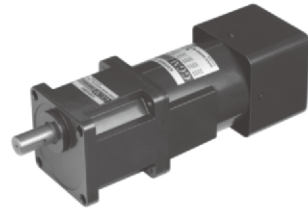

K9IP120F□-SU + K9P□B

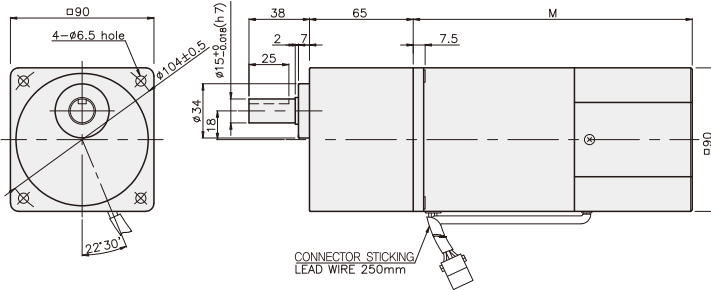

#### WEIGHT

PART	WEIGHT(kg)
MOTOR	3,54
DECIMAL GEAR HEAD	0,62

#### DIMENSION TABLE

PART No.	M	Application Model
01	155	50Hz
02	135	60Hz

#### DIMENSION TABLE

PART No.	L	Application Model	Mounting BOLT
01	65	K9P3~200B	M6 P1,0 X 95
02	40	K9P10BX	M6 P1,0 X 140

K9IP120F□-SU + K9P□BF

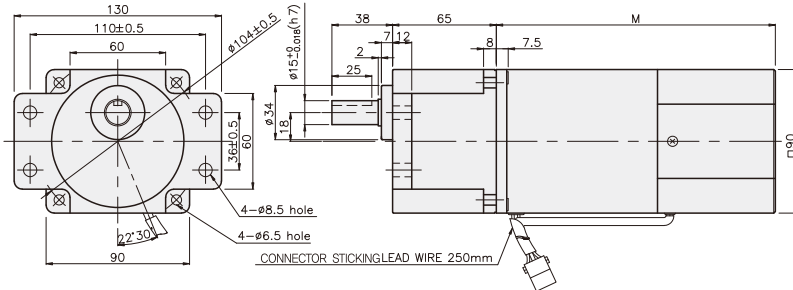

#### WEIGHT

PART	WEIGHT(kg)
K9P3~10B	1,22
K9P12,5~20B	1,32
K9P25~60B	1,42
K9P75~200B	1,45

#### DIMENSION TABLE

PART No.	L	Application Model	Mounting BOLT
01	65	K9P3~200BF	M6 P1,0 X 25
02	40	K9P10BX	M6 P1,0 X 65

#### WEIGHT

PART	WEIGHT(kg)
K9P3~10BF	1,22
K9P12,5~20BF	1,30
K9P25~60BF	1,42
K9P75~200BF	1,44

#### DIMENSION TABLE

PART No.	L	Application Model	Mounting BOLT
01	85	K9P3~200BU	M6 P1,0 X 20
02	40	K9P10BX	M6 P1,0 X 60

#### WEIGHT

PART	WEIGHT(kg)
K9P3~10BU	1,44
K9P12,5~20BU	1,55
K9P25~60BU	1,69
K9P75~200BU	1,74

#### DIMENSION TABLE

PART No.	L	Application Model	Mounting BOLT
01	85	K9P3~200BUF	M6 P1,0 X 20
02	40	K9P10BX	M6 P1,0 X 65

#### WEIGHT

PART	WEIGHT(kg)
K9P3~10BUF	1,50
K9P12,5~20BUF	1,62
K9P25~60BUF	1,76
K9P75~200BUF	1,82

K9IP120F□-SU + K9P□BUF

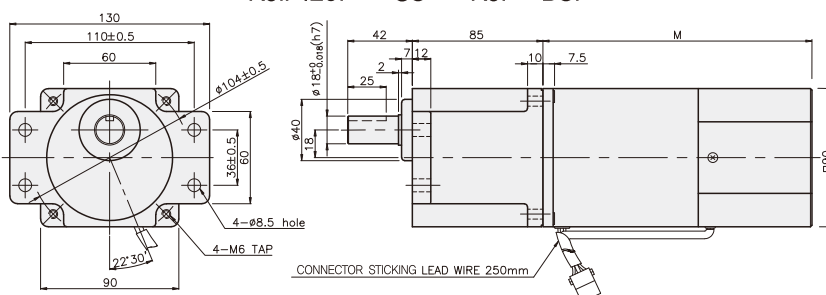

## SPEED CONTROL MOTOR - SU SERIES

### 180W

### □90mm

### INDUCTION MOTOR

K9IS180F□-SU

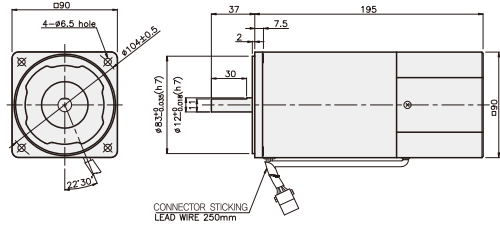
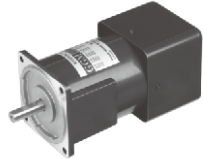

### SPECIFICATIONS

180W continuous rating, four poles

Model	Voltage (V)	Frequency (Hz)	Speed Range (rpm)	Permissible Torque		Start T. (N*m/Kgf*cm)	Current (A)	Condenser (μF)
				1200rpm (N*m/Kgf*cm)	90rpm (N*m/Kgf*cm)			
K9I□180FJ-SU	100	50	90 ~ 1400	0.9/9	0.35/3.5	0.6/6	5.2	50
		60	90 ~ 1700			0.65/6.5		
K9I□180FU-SU	110	60	90 ~ 1700	0.9/9	0.35/3.5	0.52/5.2	4.8	35
	115					0.55/5.5		
K9I□180FL-SU	200	50	90 ~ 1400	0.9/9	0.3/3	0.5/5	2.2	12
		60	90 ~ 1700			0.42/4.2		
K9I□180FC-SU	220	50	90 ~ 1400	0.9/9	0.3/3	0.45/4.5	2.2	8
		60	90 ~ 1700			0.42/4.2		
	230	50	90 ~ 1400	1/10	0.33/3.3	0.53/5.3	2.4	
		60	90 ~ 1700			0.5/5		
K9I□180FD-SU	240	50	90 ~ 1400	1/10	0.33/3.3	0.6/6	2	8

※ □ : SHAFT SHAPE ( S : STRAIGHT, P : PINION )

### RATED TORQUE OF GEARHEAD

#### ● Single-phase 100V/115V

unit = above : N·m / below : Kgf·cm

Model	Ratio	Speed(rpm)																							
		3	3.6	5	6	7.5	9	10	12.5	15	18	20	25	30	36	40	50	60	75	90	100	120	150	180	200
K9I□180F□-SU	1200	2.19	2.62	3.65	4.37	5.47	6.56	7.29	8.20	9.84	11.81	13.12	14.76	17.71	21.26	23.62	29.52	30	30	30	30	30	30	30	30
	90	0.85	1.02	1.42	1.70	2.13	2.55	2.84	3.19	3.83	4.59	5.10	5.74	6.89	8.27	9.19	11.48	13.78	15.50	18.60	20.67	24.80	30	30	30
K9P□BU, BUF	90	8.5	10.2	14.2	17.0	21.3	25.5	28.4	31.9	38.3	45.9	51.0	57.4	68.9	82.7	91.9	114.8	137.8	155.0	186.0	206.7	248.0	300	300	300

#### ● Single-phase 200V/240V

unit = above : N·m / below : Kgf·cm

Model	Ratio	Speed(rpm)																							
		3	3.6	5	6	7.5	9	10	12.5	15	18	20	25	30	36	40	50	60	75	90	100	120	150	180	200
K9I□180F□-SU	1200	200V/220V	2.19	2.62	3.65	4.37	5.47	6.56	7.29	8.20	9.84	11.81	13.12	14.76	17.71	21.26	23.62	29.52	30	30	30	30	30	30	30
		50Hz/60Hz	2.19	2.62	3.65	4.37	5.47	6.56	7.29	8.20	9.84	11.81	13.12	14.76	17.71	21.26	23.62	29.52	30	30	30	30	30	30	30
	90	230V/50Hz/60Hz	2.43	2.92	4.05	4.86	6.08	7.29	8.10	3.19	10.94	13.12	14.58	16.40	19.68	23.62	26.24	30	30	30	30	30	30	30	30
		240V/50Hz	2.43	2.92	4.05	4.86	6.08	7.29	8.10	3.19	10.94	13.12	14.58	16.40	19.68	23.62	26.24	30	30	30	30	30	30	30	30
K9P□BU, BUF	90	200V/220V	0.73	0.87	1.22	1.46	1.82	2.19	2.43	2.73	3.28	3.94	4.37	4.92	5.90	7.09	7.87	9.84	11.81	13.29	15.94	17.71	21.26	26.57	30
		50Hz/60Hz	0.73	0.87	1.22	1.46	1.82	2.19	2.43	2.73	3.28	3.94	4.37	4.92	5.90	7.09	7.87	9.84	11.81	13.29	15.94	17.71	21.26	26.57	30
K9P□BU, BUF	90	230V/50Hz/60Hz	0.80	0.96	1.34	1.60	2.00	2.41	2.41	3.34	4.01	4.81	5.35	5.41	6.50	7.79	8.66	10.83	12.99	14.61	17.54	19.49	23.38	29.23	30
		240V/50Hz	0.80	0.96	1.34	1.60	2.00	2.41	2.41	3.34	4.01	4.81	5.35	5.41	6.50	7.79	8.66	10.83	12.99	14.61	17.54	19.49	23.38	29.23	30

- \* Gearhead and decimal gearhead are sold separately.
- \* The code in □ of gearhead model is for gear ratio.
- \*  color indicates that the output shaft of the geared motor rotates in the same direction as the output shaft of the motor, Others indicate rotation in the opposite direction.
- \* If you are to have less ratio than the ratio in the table, you can install the decimal gearhead, which has one tenth of the ratio, between the gearhead and the motor. In this case, the permissible torque is 30N·m/300kgf·cm.
- \* RPM is based on motor's synchronous rpm (50HZ:1500rpm, 60HZ:1800rpm) and calculated by dividing gear ratio. Actual rpm is 2~20% less than indicating rpm according to load size.

SPEED CONTROL MOTOR - SU SERIES

## GEARHEADS

### CONNECTION DIAGRAMS

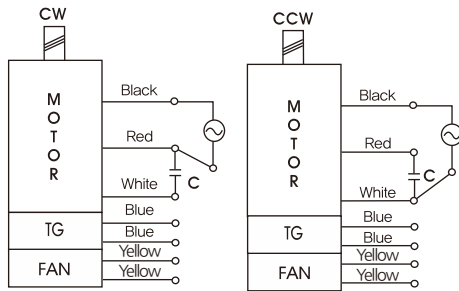

※The direction of motor rotation is as viewed from the front shaft end of the motor

### DIMENSIONS

K9P□BU

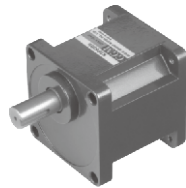

K9P□BUF

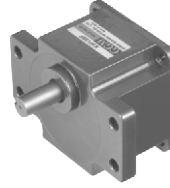

### DECIMAL GEARHEAD

K9P10BX

### KEY SPEC

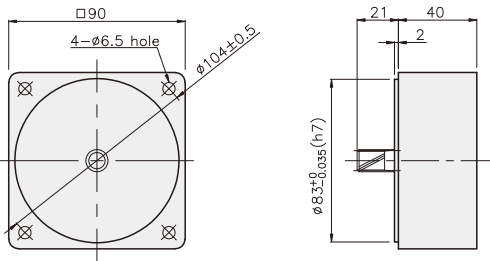

● KEY

● KEY GROOVE

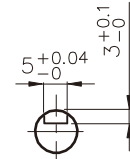
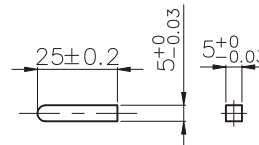

### GEARHEAD

K9P□BU

K9P□BUF

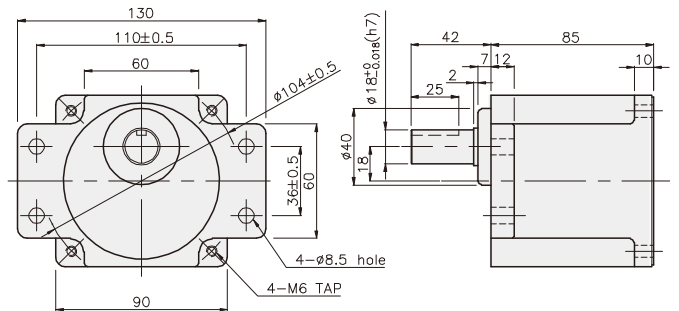
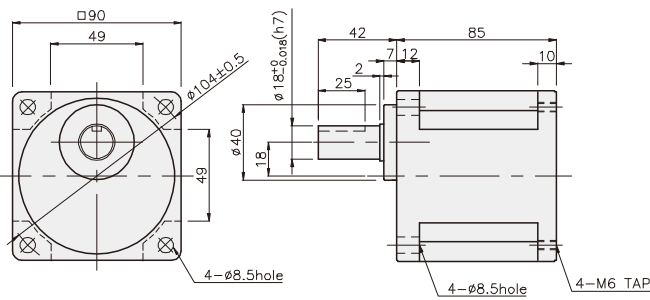

## GEARHEADS

### DIMENSIONS

K9IP180F□-SU + K9P□BU

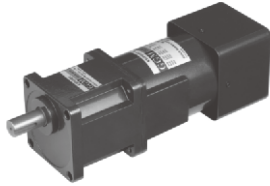

K9IP180F□-SU + K9P□BUF

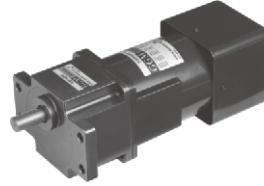

#### WEIGHT

PART	WEIGHT(kg)
MOTOR	4,24
DECIMAL GEAR HEAD	0,62

#### DIMENSION TABLE

PART No.	L	Application Model	Mounting BOLT
01	85	K9P3~200B	M6 P1,0 X 20
02	40	K9P10BX	M6 P1,0 X 60

#### WEIGHT

PART	WEIGHT(kg)
K9P3~10BU	1,44
K9P12,5~20BU	1,55
K9P25~60BU	1,69
K9P75~200BU	1,74

#### DIMENSION TABLE

PART No.	L	Application Model	Mounting BOLT
01	85	K9P3~200BUF	M6 P1,0 X 20
02	40	K9P10BX	M6 P1,0 X 60

#### WEIGHT

PART	WEIGHT(kg)
K9P3~10BUF	1,50
K9P12,5~20BUF	1,62
K9P25~60BUF	1,76
K9P75~200BUF	1,82

K9IP180F□-SU + K9P□BU

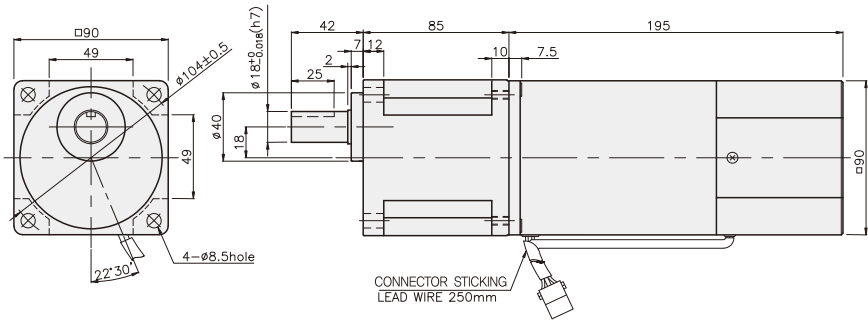

K9IP180F□-SU + K9P□BUF

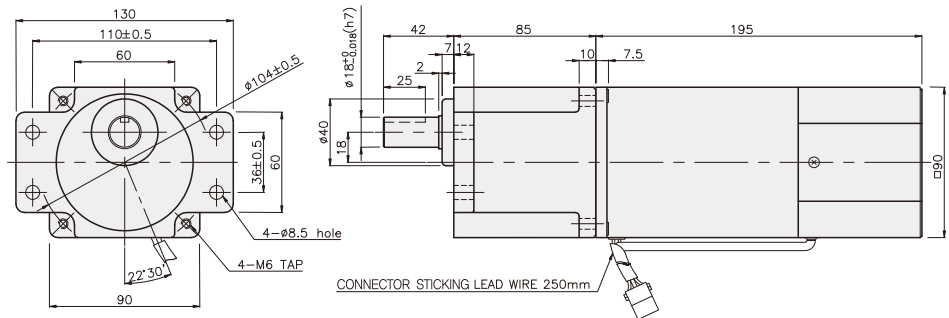

## SPEED CONTROL MOTOR - SU SERIES

### 6W

### □60mm

### REVERSIBLE MOTOR

K6RS6N□-SU

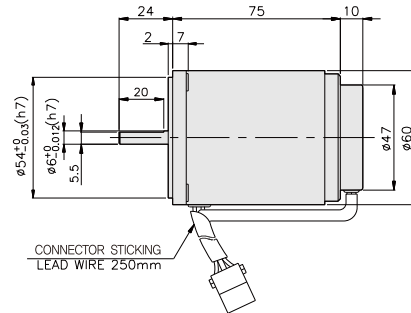
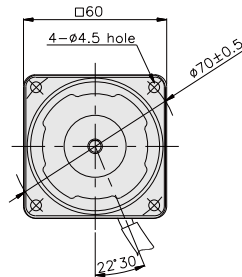

### SPECIFICATIONS

6W 30 minutes rating, four poles

Model	Voltage (V)	Frequency (Hz)	Speed (rpm)	Permissible Torque		Start T. (N·m/kgf·cm)	Current (A)	Condenser (μF)
				1200rpm	90rpm			
				(N·m/kgf·cm)	(N·m/kgf·cm)			
K6R□6NJ-SU	100	50	90 ~ 1400	0.052/0.52	0.035/0.35	0.027/0.27	0.28	3
		60	90 ~ 1700					
K6R□6NU-SU	110	60	90 ~ 1700	0.052/0.52	0.035/0.35	0.035/0.35	0.32	2.5
	115							
K6R□6NL-SU	200	50	90 ~ 1400	0.06/0.6	0.038/0.38	0.037/0.37	0.2	1
		60	90 ~ 1700					
K6R□6NC-SU	220	50	90 ~ 1400	0.052/0.52	0.03/0.3	0.035/0.35	0.2	0.8
		60	90 ~ 1700			0.033/0.33		
	230	50	90 ~ 1400	0.06/0.6	0.038/0.38	0.035/0.35	0.2	
		60	90 ~ 1700			0.033/0.33		
K6R□6ND-SU	240	50	90 ~ 1400	0.052/0.52	0.03/0.3	0.035/0.35	0.22	0.6

※ □ : SHAFT SHAPE ( S : STRAIGHT, G : PINION )

### RATED TORQUE OF GEARHEAD

#### ● Single-phase 100V/115V

unit = above : N·m / below : kgf·cm

Model Motor/Gearhead	Ratio Speed(rpm)	Gear Ratio																								
		3	3.6	5	6	7.5	9	10	12.5	15	18	20	25	30	36	40	50	60	75	90	100	120	150	180	200	250
K6R□6N□-SU K6G□B(C)	1200	0.13 1.3	0.15 1.5	0.21 2.1	0.25 2.5	0.32 3.2	0.38 3.8	0.42 4.2	0.53 5.3	0.63 6.3	0.76 7.6	0.76 7.6	0.95 9.5	1.14 11.4	1.36 13.6	1.52 15.2	1.71 17.1	2.05 20.5	2.56 25.6	2.95 29.5	3	3	3	3	3	3
	90	0.09 0.9	0.10 1.0	0.14 1.4	0.17 1.7	0.21 2.1	0.26 2.6	0.28 2.8	0.35 3.5	0.43 4.3	0.51 5.1	0.51 5.1	0.64 6.4	0.77 7.7	0.92 9.2	1.02 10.2	1.15 11.5	1.38 13.8	1.72 17.2	2.07 20.7	2.30 23.0	2.76 27.6	3	3	3	3

#### ● Single-phase 200V/240V

unit = above : N·m / below : kgf·cm

Model Motor/Gearhead	Ratio Speed(rpm)	Gear Ratio																								
		3	3.6	5	6	7.5	9	10	12.5	15	18	20	25	30	36	40	50	60	75	90	100	120	150	180	200	250
K6R□6N□-SU K6G□B(C)	1200	200V/230V 50Hz/60Hz	0.15 1.5	0.17 1.7	0.24 2.4	0.29 2.9	0.36 3.6	0.44 4.4	0.49 4.9	0.61 6.1	0.73 7.3	0.87 8.7	0.87 8.7	1.09 10.9	1.31 13.1	1.57 15.7	1.75 17.5	1.97 19.7	2.36 23.6	2.95 29.5	3	3	3	3	3	3
		200V 50Hz/60Hz 240V/50Hz	0.13 1.3	0.15 1.5	0.21 2.1	0.25 2.5	0.32 3.2	0.38 3.8	0.42 4.2	0.53 5.3	0.63 6.3	0.76 7.6	0.76 7.6	0.95 9.5	1.14 11.4	1.36 13.6	1.52 15.2	1.71 17.1	2.05 20.5	2.56 25.6	3	3	3	3	3	3
	90	200V/230V 50Hz/60Hz	0.09 0.9	0.11 1.1	0.15 1.5	0.18 1.8	0.23 2.3	0.28 2.8	0.31 3.1	0.38 3.8	0.46 4.6	0.55 5.5	0.55 5.5	0.69 6.9	0.83 8.3	1.00 10.0	1.11 11.1	1.25 12.5	1.50 15.0	1.87 18.7	2.24 22.4	2.49 24.9	2.99 29.9	3	3	3
		220V 50Hz/60Hz 240V/50Hz	0.07 0.7	0.09 0.9	0.12 1.2	0.15 1.5	0.18 1.8	0.22 2.2	0.24 2.4	0.30 3.0	0.36 3.6	0.44 4.4	0.44 4.4	0.55 5.5	0.66 6.6	0.79 7.9	0.87 8.7	0.98 9.8	1.18 11.8	1.48 14.8	1.77 17.7	1.97 19.7	2.36 23.6	2.95 29.5	3	3

\* Gearhead and decimal gearhead are sold separately.

\* The code in □ of gearhead model is for gear ratio.

\*   color indicates that the output shaft of the geared motor rotates in the same direction as the output shaft of the motor, Others indicate rotation in the opposite direction.

\* If you are to have less ratio than the ratio in the table, you can install the decimal gearhead, which has one tenth of the ratio, between the gearhead and the motor. In this case, the permissible torque is 3N·m/30kgf·cm.

\* RPM is based on motor's synchronous rpm (50HZ:1500rpm, 60HZ:1800rpm) and calculated by dividing gear ratio. Actual rpm is 2~20% less than indicating rpm according to load size.



## GEARHEAD

### CONNECTION DIAGRAMS

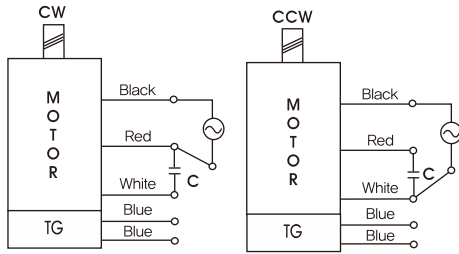

※The direction of motor rotation is as viewed from the front shaft end of the motor

### DIMENSIONS

K6G□B(C)



K6RG6N□-SU + K6G□B(C)



DECIMAL GEARHEAD

K6G10BX

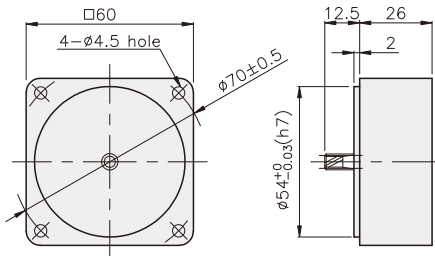

GEARHEAD

K6G□B(C)

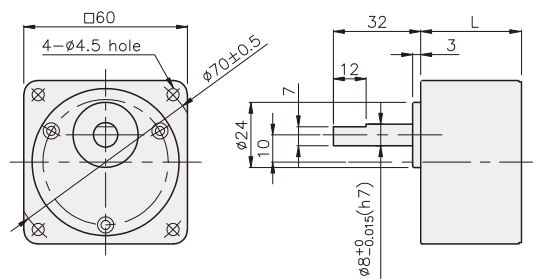

#### DIMENSION TABLE

PART No.	L	Application Model	Mounting BOLT
01	30	K6G3~18B(C)	M4 P0.7 × 50
02	40	K6G20~250B(C)	M4 P0.7 × 60
03	26	K6G10BX	M4 P0.7 × 85

#### WEIGHT

PART	WEIGHT(kg)	
MOTOR	0.79	
DECIMAL GEARHEAD	0.22	
GEAR HEAD	K6G3~18B(C)	0.26
	K6G20~40B(C)	0.33
	K6G50~250B(C)	0.36

K6RG6N□-SU + K6G□B(C)

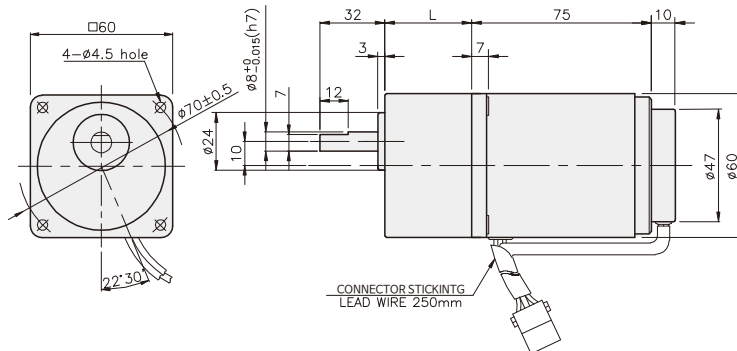

SPEED CONTROL MOTOR  
- SU SERIES

## SPEED CONTROL MOTOR - SU SERIES

15W

□70mm

REVERSIBLE MOTOR

K7RS15N□-SU

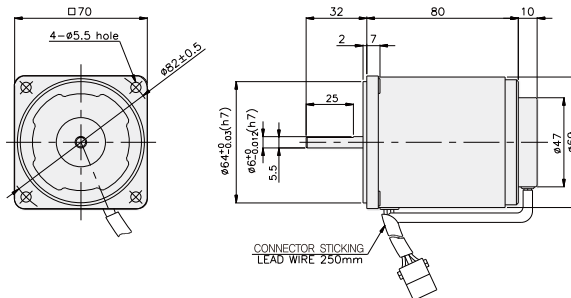
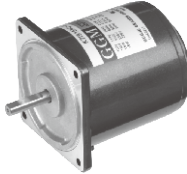

### SPECIFICATIONS

15W 30 minutes rating, four poles

Model	Voltage (V)	Frequency (Hz)	Speed (rpm)	Permissible Torque		Start T. (N·m/kgf·cm)	Current (A)	Condenser (μF)
				1200rpm (N·m/kgf·cm)	90rpm (N·m/kgf·cm)			
K7R□15NJ-SU	100	50	90 ~ 1400	0.14/1.4	0.05/0.5	0.085/0.85	0.56	7
			90 ~ 1700					
K7R□15NU-SU	110	60	90 ~ 1700	0.14/1.4	0.05/0.5	0.085/0.85	0.58	6
	115							
K7R□15NL-SU	200	50	90 ~ 1400	0.135/1.35	0.055/0.55	0.09/0.9	0.31	2
			90 ~ 1700					
K7R□15NC-SU	220	50	90 ~ 1400	0.135/1.35	0.05/0.5	0.08/0.8	0.3	1.5
			90 ~ 1700					
		60	90 ~ 1400	0.115/1.15	0.055/0.55	0.085/0.85	0.33	
			90 ~ 1700					
K7R□15ND-SU	240	50	90 ~ 1400	0.135/1.35	0.05/0.5	0.09/0.9	0.34	
			90 ~ 1700					

※ □ : SHAFT SHAPE ( S : STRAIGHT, G : PINION )

### RATED TORQUE OF GEARHEAD

#### ● Single-phase 100V/115V

unit = above : N·m / below : kgf·cm

Model Motor/Gearhead	Ratio Speed(rpm)																								
		3	36	5	6	7.5	9	10	12.5	15	18	20	25	30	36	40	50	60	75	90	100	120	150	180	200
K7R□15N□-SU K7G□B(C)	1200	0.34 3.4	0.41 4.1	0.57 5.7	0.68 6.8	0.85 8.5	1.02 10.2	1.13 11.3	1.42 14.2	1.70 17.0	2.04 20.4	2.04 20.4	2.55 25.5	3.06 30.6	3.67 36.7	4.08 40.8	4.59 45.9	5 50	5 50	5 50	5 50	5 50	5 50	5 50	5 50
	90	0.12 1.2	0.15 1.5	0.20 2.0	0.24 2.4	0.30 3.0	0.36 3.6	0.41 4.1	0.51 5.1	0.61 6.1	0.73 7.3	0.73 7.3	0.91 9.1	1.09 10.9	1.31 13.1	1.46 14.6	1.64 16.4	1.97 19.7	2.46 24.6	2.95 29.5	3.28 32.8	3.94 39.4	4.92 49.2	5 50	5 50

#### ● Single-phase 200V/240V

unit = above : N·m / below : kgf·cm

Model Motor/Gearhead	Ratio Speed(rpm)																									
		3	36	5	6	7.5	9	10	12.5	15	18	20	25	30	36	40	50	60	75	90	100	120	150	180	200	
K7R□15N□-SU K7G□B(C)	1200	200V/230V 50Hz/60Hz	0.33 3.3	0.39 3.9	0.55 5.5	0.66 6.6	0.82 8.2	0.98 9.8	1.09 10.9	1.37 13.7	1.64 16.4	1.97 19.7	1.97 19.7	2.46 24.6	2.95 29.5	3.54 35.4	3.94 39.4	4.43 44.3	5 50	5 50	5 50	5 50	5 50	5 50	5 50	5 50
		200V 50Hz/60Hz 240V/50Hz	0.28 2.8	0.34 3.4	0.47 4.7	0.56 5.6	0.70 7.0	0.84 8.4	0.93 9.3	1.16 11.6	1.40 14.0	1.68 16.8	1.68 16.8	2.10 21.0	2.52 25.2	3.02 30.2	3.35 33.5	3.77 37.7	4.53 45.3	5 50	5 50	5 50	5 50	5 50	5 50	5 50
	90	200V/230V 50Hz/60Hz	0.13 1.3	0.16 1.6	0.22 2.2	0.27 2.7	0.33 3.3	0.40 4.0	0.45 4.5	0.56 5.6	0.67 6.7	0.80 8.0	0.80 8.0	1.00 10.0	1.20 12.0	1.44 14.4	1.60 16.0	1.80 18.0	2.17 21.7	2.71 27.1	3.25 32.5	3.61 36.1	4.33 43.3	5 50	5 50	
		220V 50Hz/60Hz 240V/50Hz	0.12 1.2	0.15 1.5	0.20 2.0	0.24 2.4	0.30 3.0	0.36 3.6	0.41 4.1	0.51 5.1	0.61 6.1	0.73 7.3	0.73 7.3	0.91 9.1	1.09 10.9	1.31 13.1	1.46 14.6	1.64 16.4	1.97 19.7	2.46 24.6	2.95 29.5	3.28 32.8	3.94 39.4	4.92 49.2	5 50	5 50

\* Gearhead and decimal gearhead are sold separately.

\* The code in □ of gearhead model is for gear ratio.

\* ■ color indicates that the output shaft of the geared motor rotates in the same direction as the output shaft of the motor. Others indicate rotation in the opposite direction.

\* If you are to have less ratio than the ratio in the table, you can install the decimal gearhead, which has one tenth of the ratio, between the gearhead and the motor. In this case, the permissible torque is 3N·m/30kgf·cm.

\* RPM is based on motor's synchronous rpm (50Hz:1500rpm, 60Hz:1800rpm) and calculated by dividing gear ratio. Actual rpm is 2~20% less than indicating rpm according to load size.

## GEARHEAD

### CONNECTION DIAGRAMS

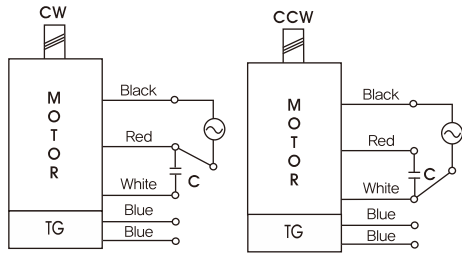

※The direction of motor rotation is as viewed from the front shaft end of the motor

### DIMENSIONS

K7G□B(C)



K7RG15N□-SU + K7G□B(C)

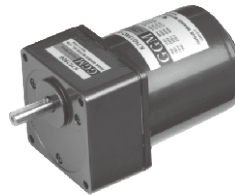

DECIMAL GEARHEAD  
K7G10BX

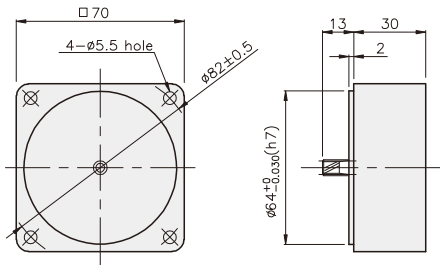

GEARHEAD  
K7G□B(C)

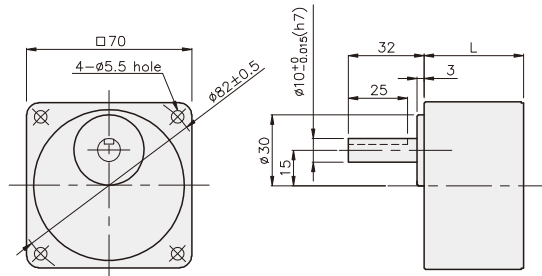

### KEY SPEC

- KEY
- KEY GROOVE

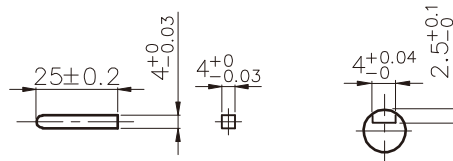

### DIMENSION TABLE

PART No.	L	Application Model	Mounting BOLT
01	32	K7G3~18B(C)	M5 P0.8 × 50
02	42	K7G20~200B(C)	M5 P0.8 × 65
03	30	K7G10BX	M5 P0.8 × 90

### WEIGHT

PART	WEIGHT(kg)	
MOTOR	1.16	
DECIMAL GEARHEAD	0.32	
GEAR HEAD	K7G3~18B(C)	0.36
	K7G20~40B(C)	0.46
	K7G50~200B(C)	0.51

K7RG15N□-SU + K7G□B(C)

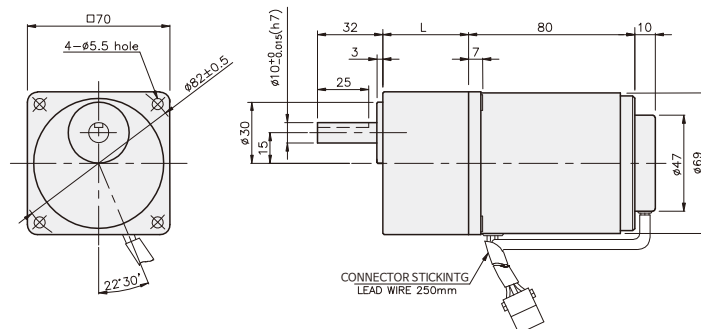

## SPEED CONTROL MOTOR - SU SERIES

### 25W

### □80mm

### REVERSIBLE MOTOR

K8RS25N□-SU

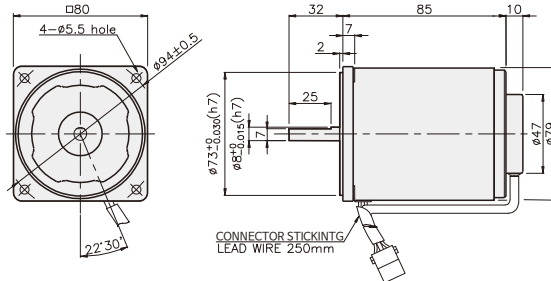

### SPECIFICATIONS

25W 30 minutes rating, four poles

Model	Voltage (V)	Frequency (Hz)	Speed (rpm)	Permissible Torque		Start T. (N·m/kgf·cm)	Current (A)	Condenser (μF)
				1200rpm (N·m/kgf·cm)	90rpm (N·m/kgf·cm)			
K8R□25NJ-SU	100	50	90 ~ 1400	0.22/2.2	0.06/0.6	0.105/1.05	0.85	10
		60	90 ~ 1700					
K8R□25NU-SU	110	60	90 ~ 1700	0.22/2.2	0.06/0.6	0.1/1	0.7	6
	115						0.75	
K8R□25NL-SU	200	50	90 ~ 1400	0.21/2.1	0.055/0.55	0.11/1.1	0.4	2.5
		60	90 ~ 1700	0.16/1.6	0.048/0.48		0.43	
K8R□25NC-SU	220	50	90 ~ 1400	0.21/2.1	0.055/0.55	0.09/0.9	0.4	2
		60	90 ~ 1700	0.16/1.6	0.048/0.48			
	230	50	90 ~ 1400	0.21/2.1	0.055/0.55	0.1/1		
		60	90 ~ 1700	0.16/1.6	0.048/0.48			
K8R□25ND-SU	240	50	90 ~ 1400	0.21/2.1	0.055/0.55	0.09/0.9	0.43	1.5

※ □ : SHAFT SHAPE ( S : STRAIGHT, G : PINION )

### RATED TORQUE OF GEARHEAD

#### ● Single-phase 100V/115V

unit = above : N·m / below : kgf·cm

Model Motor/Gearhead	Ratio Speed(rpm)																										
		3	36	5	6	7.5	9	10	12.5	15	18	20	25	30	36	40	50	60	75	90	100	120	150	180	200	250	
K8R□25N□-SU K8G□B(C)	1200	0.53 5.3	0.64 6.4	0.89 8.9	1.07 10.7	1.34 13.4	1.60 16.0	1.78 17.8	2.23 22.3	2.67 26.7	3.21 32.1	3.21 32.1	4.01 40.1	4.81 48.1	5.77 57.7	6.42 64.2	7.22 72.2	8 80	8 80	8 80	8 80	8 80	8 80	8 80	8 80	8 80	8 80
	90	0.15 1.5	0.17 1.7	0.24 2.4	0.29 2.9	0.36 3.6	0.44 4.4	0.49 4.9	0.61 6.1	0.73 7.3	0.87 8.7	0.87 8.7	1.09 10.9	1.31 13.1	1.57 15.7	1.75 17.5	1.97 19.7	2.36 23.6	2.95 29.5	3.54 35.4	3.94 39.4	4.72 47.2	5.90 59.0	7.09 70.9	8 80	8 80	8 80

#### ● Single-phase 200V/240V

unit = above : N·m / below : kgf·cm

Model Motor/Gearhead	Ratio Speed(rpm)																										
		3	36	5	6	7.5	9	10	12.5	15	18	20	25	30	36	40	50	60	75	90	100	120	150	180	200	250	
K8R□25N□-SU K8G□B(C)	1200	200V/220V 230V/240V 50Hz	0.51 5.1	0.61 6.1	0.85 8.5	1.02 10.2	1.28 12.8	1.53 15.3	1.70 17.0	2.13 21.3	2.55 25.5	3.06 30.6	3.06 30.6	3.83 38.3	4.59 45.9	5.51 55.1	6.12 61.2	6.89 68.9	8 80	8 80	8 80	8 80	8 80	8 80	8 80	8 80	8 80
		200V/220V 230V/240V 60Hz	0.39 3.9	0.47 4.7	0.65 6.5	0.78 7.8	0.97 9.7	1.17 11.7	1.30 13.0	1.62 16.2	1.94 19.4	2.33 23.3	2.33 23.3	2.92 29.2	3.50 35.0	4.20 42.0	4.67 46.7	5.25 52.5	6.30 63.0	7.87 78.7	8 80	8 80	8 80	8 80	8 80	8 80	8 80
	90	200V/220V 230V/240V 50Hz	0.13 1.3	0.16 1.6	0.22 2.2	0.27 2.7	0.33 3.3	0.40 4.0	0.45 4.5	0.56 5.6	0.67 6.7	0.80 8.0	0.80 8.0	1.00 10.0	1.20 12.0	1.44 14.4	1.60 16.0	1.80 18.0	2.17 21.7	2.71 27.1	3.25 32.5	3.61 36.1	4.33 43.3	5.41 54.1	6.50 65.0	7.22 72.2	8 80
		200V/220V 230V/240V 60Hz	0.12 1.2	0.14 1.4	0.19 1.9	0.23 2.3	0.29 2.9	0.35 3.5	0.39 3.9	0.49 4.9	0.58 5.8	0.70 7.0	0.70 7.0	0.87 8.7	1.05 10.5	1.26 12.6	1.40 14.0	1.57 15.7	1.89 18.9	2.36 23.6	2.83 28.3	3.15 31.5	3.78 37.8	4.72 47.2	5.67 56.7	6.30 63.0	7.87 78.7

- \* Gearhead and decimal gearhead are sold separately.
- \* The code in □ of gearhead model is for gear ratio.
- \* ■ color indicates that the output shaft of the geared motor rotates in the same direction as the output shaft of the motor, Others indicate rotation in the opposite direction.
- \* If you are to have less ratio than the ratio in the table, you can install the decimal gearhead, which has one tenth of the ratio, between the gearhead and the motor, In this case, the permissible torque is 3N·m/30kgf·cm.
- \* RPM is based on motor's synchronous rpm (50HZ:1500rpm, 60HZ:1800rpm) and calculated by dividing gear ratio. Actual rpm is 2~20% less than indicating rpm according to load size.

## GEARHEAD

### CONNECTION DIAGRAMS

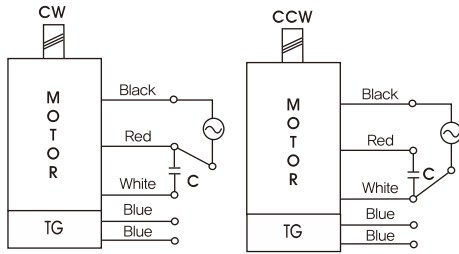

※The direction of motor rotation is as viewed from the front shaft end of the motor

### DIMENSIONS

K8G□B(C)



K8RG25N□-SU + K8G□B(C)

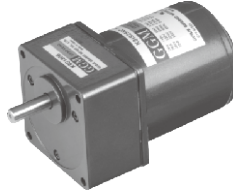

DECIMAL GEARHEAD  
K8G10BX

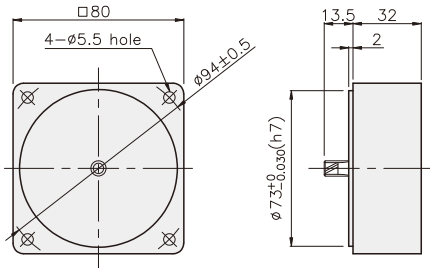

GEARHEAD  
K8G□B(C)

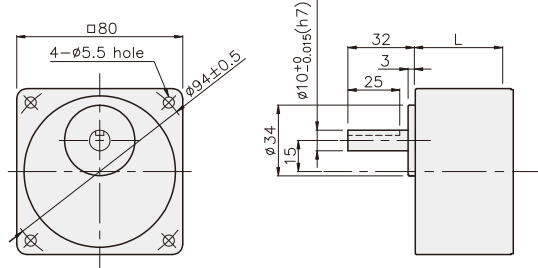

### KEY SPEC

- KEY
- KEY GROOVE

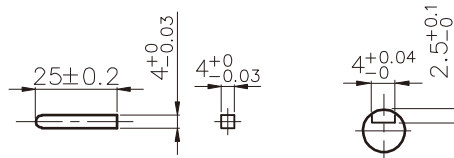

### DIMENSION TABLE

PART No.	L	Application Model	Mounting BOLT
01	32	K8G3~18B(C)	M5 P0.8 × 50
02	42.5	K8G20~250B(C)	M5 P0.8 × 65
03	32	K8G10BX	M5 P0.8 × 95

### WEIGHT

PART	WEIGHT(kg)	
MOTOR	1.60	
DECIMAL GEARHEAD	0.46	
GEAR HEAD	K8G3~18B(C)	0.51
	K8G20~40B(C)	0.64
	K8G50~250B(C)	0.70

K8RG25N□-SU + K8G□B(C)

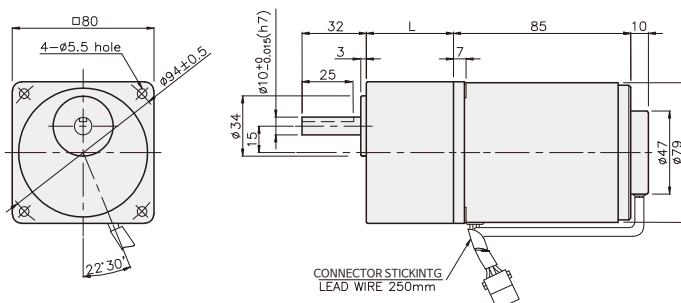

## SPEED CONTROL MOTOR - SU SERIES

40W

□90mm

REVERSIBLE MOTOR

K9RS40N□-SU

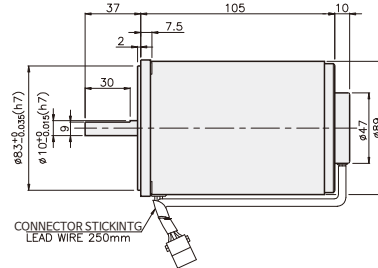
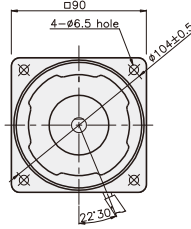

### SPECIFICATIONS

40W 30 minutes rating, four poles

Model	Voltage (V)	Frequency (Hz)	Speed (rpm)	Permissible Torque		Start T. (N·m/kgf·cm)	Current (A)	Condenser (μF)	
				1200rpm (N·m/kgf·cm)	90rpm (N·m/kgf·cm)				
K9R□40NJ-SU	100	50	90 ~ 1400	0.3/3	0.075/0.75	0.17/1.7	1.5	16	
		60	90 ~ 1700			0.18/1.8			
K9R□40NU-SU	110	60	90 ~ 1700	0.3/3	0.075/0.75	0.14/1.4	1.5	10	
	115					1.3			
K9R□40NL-SU	200	50	90 ~ 1400	0.33/3.3	0.07/0.7	0.17/1.7	0.65	4	
		60	90 ~ 1700	0.26/2.6		0.72			
K9R□40NC-SU	220	50	90 ~ 1400	0.33/3.3	0.07/0.7	0.17/1.7	0.6	3.5	
		60	90 ~ 1700	0.26/2.6		0.16/1.6	0.64		
		230	50	90 ~ 1400		0.33/3.3	0.17/1.7		0.6
			60	90 ~ 1700		0.26/2.6	0.16/1.6		0.64
K9R□40ND-SU	240	50	90 ~ 1400	0.33/3.3	0.07/0.7	0.16/1.6	0.63	3	

※ □ : SHAFT SHAPE ( S : STRAIGHT, G : PINION )

### RATED TORQUE OF GEARHEAD

#### ● Single-phase 100V/115V

unit = above : N·m / below : kgf·cm

Model Motor/Gearhead	Ratio Speed(rpm)	Ratio																							
		3	3.6	5	6	7.5	9	10	12.5	15	18	20	25	30	36	40	50	60	75	90	100	120	150	180	200
K9R□40N□-SU K9G□B(C)	1200	0.63 6.3	0.76 7.6	1.05 10.5	1.26 12.6	1.58 15.8	1.90 19.0	2.11 21.1	2.63 26.3	3.16 31.6	3.79 37.9	4.74 47.4	5.69 56.9	6.82 68.2	7.58 75.8	8.53 85.3	10 100	10 100	10 100	10 100	10 100	10 100	10 100	10 100	10 100
	90	0.17 1.7	0.20 2.0	0.28 2.8	0.34 3.4	0.43 4.3	0.51 5.1	0.57 5.7	0.71 7.1	0.85 8.5	1.02 10.2	1.02 10.2	1.28 12.8	1.53 15.3	1.84 18.4	2.04 20.4	2.30 23.0	2.76 27.6	3.44 34.4	4.13 41.3	4.59 45.9	5.51 55.1	6.89 68.9	8.27 82.7	9.19 91.9

#### ● Single-phase 200V/240V

unit = above : N·m / below : kgf·cm

Model Motor/Gearhead	Ratio Speed(rpm)	Ratio																								
		3	3.6	5	6	7.5	9	10	12.5	15	18	20	25	30	36	40	50	60	75	90	100	120	150	180	200	
K9R□40N□-SU K9G□B(C)	1200	200V/220V	0.73	0.87	1.22	1.46	1.82	2.19	2.43	3.04	3.65	4.37	4.37	5.47	6.56	7.87	8.75	10	10	10	10	10	10	10	10	10
		230V/240V 50Hz	7.3	8.7	12.2	14.6	18.2	21.9	24.3	30.4	36.5	43.7	43.7	54.7	65.6	78.7	87.5	100	100	100	100	100	100	100	100	100
	90	200V/220V	0.56	0.67	0.93	1.12	1.40	1.68	1.86	2.33	2.79	3.35	3.35	4.19	5.03	6.04	6.71	8.38	10	10	10	10	10	10	10	10
		230V/60Hz	5.6	6.7	9.3	11.2	14.0	16.8	18.6	23.3	27.9	33.5	33.5	41.9	50.3	60.4	67.1	83.8	100	100	100	100	100	100	100	100

- \* Gearhead and decimal gearhead are sold separately.
- \* The code in □ of gearhead model is for gear ratio.
- \* ■ color indicates that the output shaft of the geared motor rotates in the same direction as the output shaft of the motor. Others indicate rotation in the opposite direction.
- \* If you are to have less ratio than the ratio in the table, you can install the decimal gearhead, which has one tenth of the ratio, between the gearhead and the motor. In this case, the permissible torque is 3N·m/30kgf·cm.
- \* RPM is based on motor's synchronous rpm (50HZ:1500rpm, 60HZ:1800rpm) and calculated by dividing gear ratio. Actual rpm is 2~20% less than indicating rpm according to load size.

## GEARHEAD

### CONNECTION DIAGRAMS

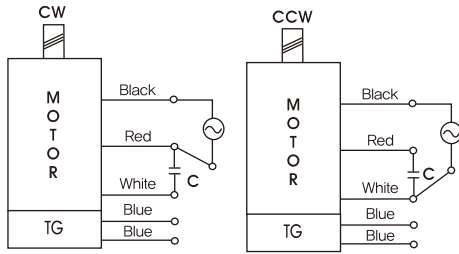

※The direction of motor rotation is as viewed from the front shaft end of the motor

### DIMENSIONS

K9G□B(C)



K9RG40N□-SU + K9G□B(C)

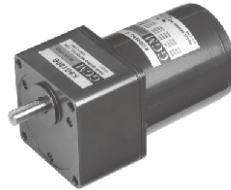

DECIMAL GEARHEAD

K9G10BX

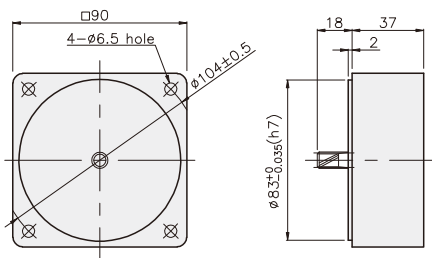

GEARHEAD

K9G□B(C)

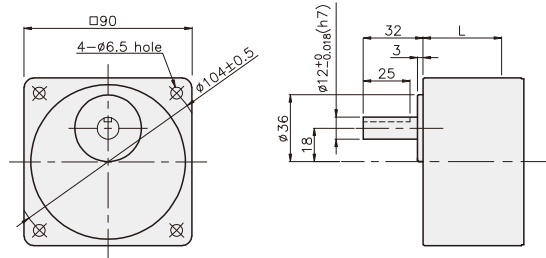

### KEY SPEC

• KEY

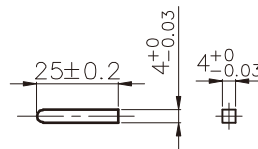

• KEY GROOVE

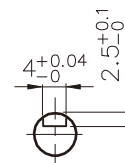

### DIMENSION TABLE

PART No.	L	Application Model	Mounting BOLT
01	42	K9G3~18B(C)	M6 P1.0 × 65
02	60	K9G20~200B(C)	M6 P1.0 × 80
03	37	K9G10BX	M6 P1.0 × 120

### WEIGHT

PART	WEIGHT(kg)	
MOTOR	2.48	
DECIMAL GEARHEAD	0.60	
GEAR HEAD	K9G3~18B(C)	0.78
	K9G20~40B(C)	1.04
	K9G50~200B(C)	1.14

K9RG40N□-SU + K9G□B(C)

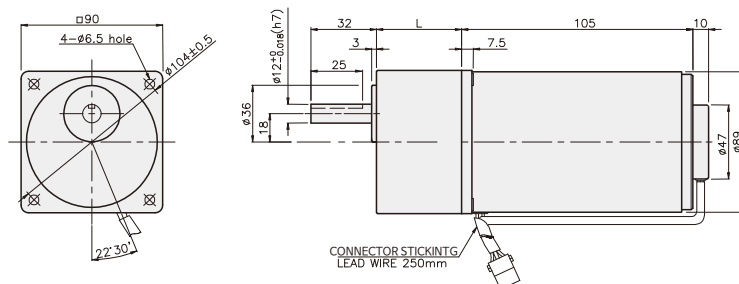



## SPEED CONTROL MOTOR - SU SERIES

60W

□90mm

REVERSIBLE MOTOR

K9RS60F□-SU

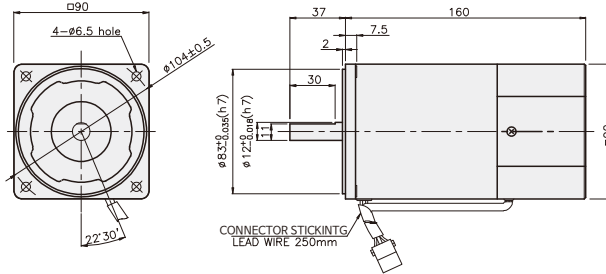
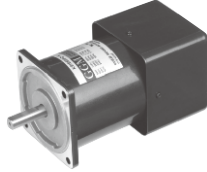

### SPECIFICATIONS

60W 30 minutes rating, four poles

Model	Voltage (V)	Frequency (Hz)	Speed (rpm)	Permissible Torque		Start T. (N·m/kgf·cm)	Current (A)	Condenser (μF)	
				1200rpm (N·m/kgf·cm)	90rpm (N·m/kgf·cm)				
K9R□60FJ-SU	100	50	90 ~ 1400	0.5/5	0.17/1.7	0.3/3	2.5	25	
			90 ~ 1700						
K9R□60FU-SU	110	60	90 ~ 1700	0.5/5	0.17/1.7	0.295/2.95	2.1	17	
	115						2.2		
K9R□60FL-SU	200	50	90 ~ 1400	0.5/5	0.15/1.5	0.26/2.6	0.72	6	
		60	90 ~ 1700	0.48/4.8	0.17/1.7	0.23/2.3	0.76		
K9R□60FC-SU	220	50	90 ~ 1400	0.5/5	0.15/1.5	0.3/3	0.95	5	
		60	90 ~ 1700	0.48/4.8	0.17/1.7	0.26/2.6	0.94		
		230	50	90 ~ 1400	0.5/5	0.15/1.5	0.3		1
			60	90 ~ 1700	0.48/4.8	0.17/1.7	0.26/2.6		1.2
K9R□60FD-SU	240	50	90 ~ 1400	0.5/5	0.15/1.5	0.32/3.2	1.2		

※ □ : SHAFT SHAPE ( S : STRAIGHT, P : PINION )

### RATED TORQUE OF GEARHEAD

#### ● Single-phase 100V/115V

unit = above : N·m / below : kgf·cm

Model	Ratio	3	3.6	5	6	7.5	9	10	12.5	15	18	20	25	30	36	40	50	60	75	90	100	120	150	180	200
Motor/Gearhead	Speed(rpm)																								
K9R□60F□-SU K9P□B, BF	1200	1.22	1.46	2.03	2.43	3.04	3.65	4.05	4.56	5.47	6.56	7.29	8.20	9.84	11.81	13.12	16.40	19.68	20	20	20	20	20	20	20
	90	0.41	0.50	0.69	0.83	1.03	1.24	1.38	1.55	1.86	2.23	2.48	2.79	3.35	4.02	4.46	5.58	6.69	7.53	9.03	10.04	12.05	15.06	18.07	20

#### ● Single-phase 200V/240V

unit = above : N·m / below : kgf·cm

Model	Ratio	3	3.6	5	6	7.5	9	10	12.5	15	18	20	25	30	36	40	50	60	75	90	100	120	150	180	200	
Motor/Gearhead	Speed(rpm)																									
K9R□60F□-SU K9P□B, BF	1200	200V/220V 230V/240V 50Hz	1.22	1.46	2.03	2.43	3.04	3.65	4.05	4.56	5.47	6.56	7.29	8.20	9.84	11.81	13.12	16.40	19.68	20	20	20	20	20	20	
		200V/220V 230V/60Hz	1.17	1.40	1.94	2.33	2.92	3.50	3.89	4.37	5.25	6.30	7.00	7.87	9.45	11.34	12.60	15.75	18.90	20	20	20	20	20	20	
	90	200V/220V 230V/240V 50Hz	0.36	0.44	0.61	0.73	0.91	1.09	1.22	1.37	1.64	1.97	2.19	2.46	2.95	3.54	3.94	4.92	5.90	6.64	7.97	8.86	10.63	13.29	15.94	17.71
		200V/220V 230V/60Hz	0.41	0.50	0.69	0.83	1.03	1.24	1.38	1.55	1.86	2.23	2.48	2.79	3.35	4.02	4.46	5.58	6.69	7.53	9.03	10.04	12.05	15.06	18.07	20

- \* Gearhead and decimal gearhead are sold separately.
- \* The code in □ of gearhead model is for gear ratio.
- \*   color indicates that the output shaft of the geared motor rotates in the same direction as the output shaft of the motor. Others indicate rotation in the opposite direction.
- \* If you are to have less ratio than the ratio in the table, you can install the decimal gearhead, which has one tenth of the ratio, between the gearhead and the motor. In this case, the permissible torque is 3N·m/30kgf·cm.
- \* RPM is based on motor's synchronous rpm (50HZ:1500rpm, 60HZ:1800rpm) and calculated by dividing gear ratio. Actual rpm is 2~20% less than indicating rpm according to load size.

## GEARHEAD

### CONNECTION DIAGRAMS

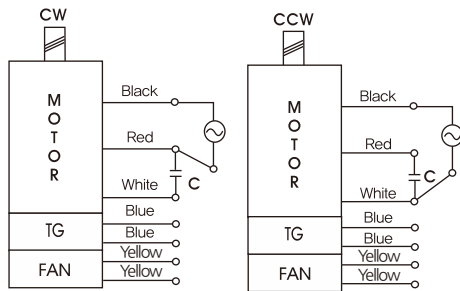

※The direction of motor rotation is as viewed from the front shaft end of the motor

### DIMENSIONS

K9P□B



K9P□BF

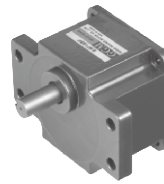

### DECIMAL GEARHEAD

K9P10BX

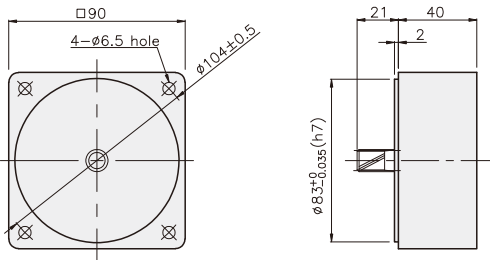

### KEY SPEC

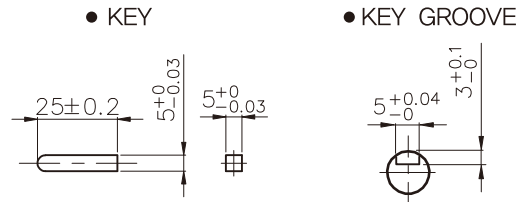

### GEARHEAD

K9P□B

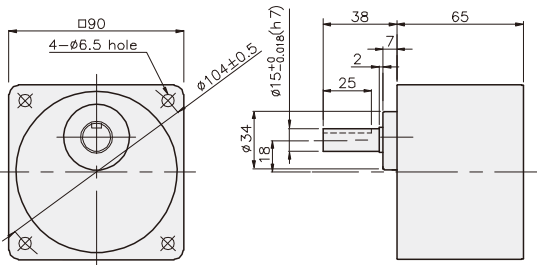

K9P□BF

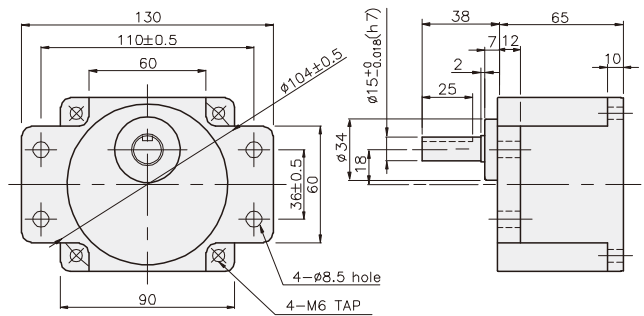

## GEARHEAD

### DIMENSIONS

K9RP60F□-SU + K9P□B

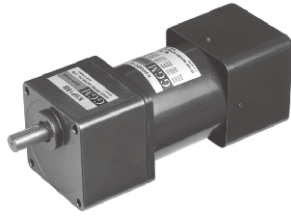

K9RP60F□-SU + K9P□BF

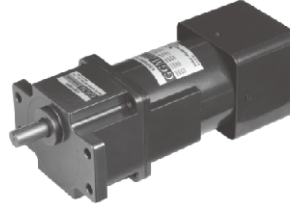

K9RP60F□-SU + K9P□B

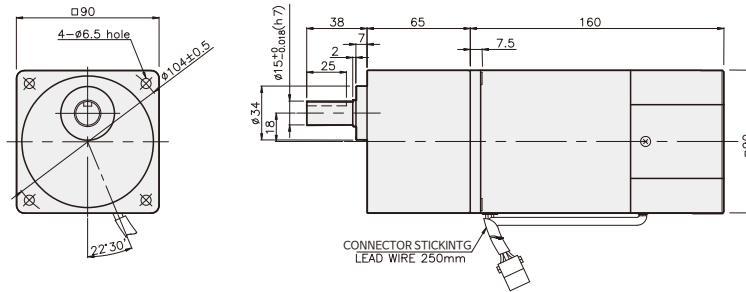

DIMENSION TABLE

PART No.	Application Model	Mounting BOLT
01	K9P3~200B	M6 P1.0 × 95
02	K9P10BX	M6 P1.0 × 140

WEIGHT

PART	WEIGHT(kg)	
MOTOR	3.06	
DECIMAL GEARHEAD	0.62	
GEAR HEAD	K9P3~10B	1.22
	K9P12.5~20B	1.32
	K9P25~60B	1.42
	K9P75~200B	1.45

K9RP60F□-SU + K9P□BF

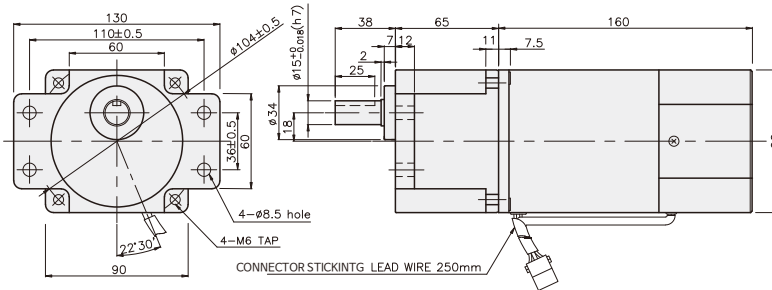

DIMENSION TABLE

PART No.	Application Model	Mounting BOLT
01	K9P3~200BF	M6 P1.0 × 20
02	K9P10BX	M6 P1.0 × 65

WEIGHT

PART	WEIGHT(kg)	
MOTOR	3.58	
DECIMAL GEARHEAD	0.62	
GEAR HEAD	K9P3~10BF	1.22
	K9P12.5~20BF	1.30
	K9P25~60BF	1.42
	K9P75~200BF	1.44

## SPEED CONTROL MOTOR - SU SERIES

### 90W

### □90mm

### REVERSIBLE MOTOR

K9RS90F□-SU

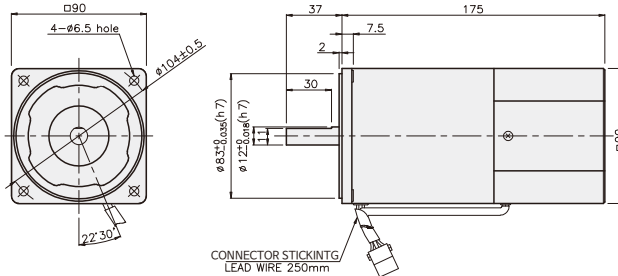
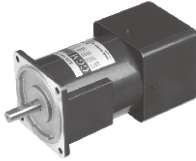

### SPECIFICATIONS

90W 30 minutes rating, four poles

Model	Voltage (V)	Frequency (Hz)	Speed (rpm)	Permissible Torque		Start T. (N·m/kgf·cm)	Current (A)	Condenser (μF)	
				1200rpm (N·m/kgf·cm)	90rpm (N·m/kgf·cm)				
K9R□90FJ-SU	100	50	90 ~ 1400	0.75/7.5	0.25/2.5	0.4/4	3.6	35	
		60	90 ~ 1700						
K9R□90FU-SU	110	60	90 ~ 1700			0.38/3.8	3	25	
	115								
K9R□90FL-SU	200	50	90 ~ 1400			0.25/2.5	0.4/4	1.4	8
		60	90 ~ 1700			0.28/2.8		1.5	
K9R□90FC-SU	220	50	90 ~ 1400			0.25/2.5	0.43/4.3	1.2	7
		60	90 ~ 1700			0.28/2.8		1.4	
	230	50	90 ~ 1400			0.25/2.5		1.2	
		60	90 ~ 1700			0.28/2.8		1.4	
K9R□90FD-SU	240	50	90 ~ 1400	0.25/2.5	0.4/4	1.3	6		

※ □ : SHAFT SHAPE ( S : STRAIGHT, P : PINION )

### RATED TORQUE OF GEARHEAD

#### ● Single-phase 100V/115V

unit = above : N·m / below : kgf·cm

Model	Ratio	3	3.6	5	6	7.5	9	10	12.5	15	18	20	25	30	36	40	50	60	75	90	100	120	150	180	200
K9R□90F□-SU K9P□B, BF	1200	1.82 182	2.04 204	3.04 304	3.65 365	4.56 456	5.47 547	6.08 608	6.83 683	8.20 820	9.84 984	10.94 1094	12.30 1230	14.76 1476	17.71 1771	19.68 1968	20 200	20 200	20 200	20 200	20 200	20 200	20 200	20 200	20 200
	90	0.61 6.1	0.73 7.3	1.01 10.1	1.22 12.2	1.52 15.2	1.82 18.2	2.03 20.3	2.28 22.8	2.73 27.3	3.28 32.8	3.65 36.5	4.10 41.0	4.92 49.2	5.90 59.0	6.56 65.6	8.20 82.0	9.84 98.4	11.07 110.7	13.29 132.9	14.76 147.6	17.71 177.1	20 200	20 200	20 200

#### ● Single-phase 200V/240V

unit = above : N·m / below : kgf·cm

Model	Ratio	3	3.6	5	6	7.5	9	10	12.5	15	18	20	25	30	36	40	50	60	75	90	100	120	150	180	200	
K9R□90F□-SU K9P□B, BF	1200	1.82 182	2.19 219	3.04 304	3.65 365	4.56 456	5.47 547	6.08 608	6.83 683	8.20 820	9.84 984	10.94 1094	12.30 1230	14.76 1476	17.71 1771	19.68 1968	20 200	20 200	20 200	20 200	20 200	20 200	20 200	20 200	20 200	
	90	200V/220V 230V/240V 50Hz	0.61 6.1	0.73 7.3	1.01 10.1	1.22 12.2	1.52 15.2	1.82 18.2	2.03 20.3	2.28 22.8	2.73 27.3	3.28 32.8	3.65 36.5	4.10 41.0	4.92 49.2	5.90 59.0	6.56 65.6	8.20 82.0	9.84 98.4	11.07 110.7	13.29 132.9	14.76 147.6	17.71 177.1	20 200	20 200	20 200
		200V/220V 230V/60Hz	0.68 6.8	0.82 8.2	1.13 11.3	1.36 13.6	1.70 17.0	2.04 20.4	2.27 22.7	2.55 25.5	3.06 30.6	3.67 36.7	4.08 40.8	4.59 45.9	5.51 55.1	6.61 66.1	7.35 73.5	9.19 91.9	11.02 110.2	12.40 124.0	14.88 148.8	16.53 165.3	19.84 198.4	20 200	20 200	20 200

- \* Gearhead and decimal gearhead are sold separately.
- \* The code in □ of gearhead model is for gear ratio.
- \*  color indicates that the output shaft of the geared motor rotates in the same direction as the output shaft of the motor. Others indicate rotation in the opposite direction.
- \* If you are to have less ratio than the ratio in the table, you can install the decimal gearhead, which has one tenth of the ratio, between the gearhead and the motor. In this case, the permissible torque is 3N·m/30kgf·cm.
- \* RPM is based on motor's synchronous rpm (50HZ:1500rpm, 60HZ:1800rpm) and calculated by dividing gear ratio. Actual rpm is 2~20% less than indicating rpm according to load size.

## GEARHEAD

### RATED TORQUE OF GEARHEAD

#### ● Single-phase 100V/115V

unit = above : N·m / below : kgf·cm

Model Motor/Gearhead	Ratio Speed(rpm)	3	3.6	5	6	7.5	9	10	12.5	15	18	20	25	30	36	40	50	60	75	90	100	120	150	180	200
		K9R□90F□-SU K9P□BU, BUF	1200	1.82 18.2	2.19 21.9	3.04 30.4	3.65 36.5	4.56 45.6	5.47 54.7	6.08 60.8	6.83 68.3	8.20 82.0	9.84 98.4	10.94 109.4	12.30 123.0	14.76 147.6	17.71 177.1	19.68 196.8	24.60 246	29.52 295	30 300	30 300	30 300	30 300	30 300
90	0.61 6.1		0.73 7.3	1.01 10.1	1.22 12.2	1.52 15.2	1.82 18.2	2.03 20.3	2.28 22.8	2.73 27.3	3.28 32.8	3.65 36.5	4.10 41.0	4.92 49.2	5.90 59.0	6.56 65.6	8.20 82.0	9.84 98.4	11.07 110.7	13.29 132.9	14.76 147.6	17.71 177.1	22.14 221.4	26.57 265.7	29.52 295.2

#### ● Single-phase 200V/240V

unit = above : N·m / below : kgf·cm

Model Motor/Gearhead	Ratio Speed(rpm)	3	3.6	5	6	7.5	9	10	12.5	15	18	20	25	30	36	40	50	60	75	90	100	120	150	180	200	
		K9R□90F□-SU K9P□BU, BUF	1200	1.82 18.2	2.19 21.9	3.04 30.4	3.65 36.5	4.56 45.6	5.47 54.7	6.08 60.8	6.83 68.3	8.20 82.0	9.84 98.4	10.94 109.4	12.30 123.0	14.76 147.6	17.71 177.1	19.68 196.8	24.60 246	29.52 295	30 300	30 300	30 300	30 300	30 300	30 300
90	200V/220V 230V/240V 50Hz		0.61 6.1	0.73 7.3	1.01 10.1	1.22 12.2	1.52 15.2	1.82 18.2	2.03 20.3	2.28 22.8	2.73 27.3	3.28 32.8	3.65 36.5	4.10 41.0	4.92 49.2	5.90 59.0	6.56 65.6	8.20 82.0	9.84 98.4	11.07 110.7	13.29 132.9	14.76 147.6	17.71 177.1	22.14 221.4	26.57 265.7	29.52 295.2
	200V/220V 230V/60Hz		0.68 6.8	0.82 8.2	1.13 11.3	1.36 13.6	1.70 17.0	2.04 20.4	2.27 22.7	2.55 25.5	3.06 30.6	3.67 36.7	4.08 40.8	4.59 45.9	5.51 55.1	6.61 66.1	7.35 73.5	9.19 91.9	11.02 110.2	12.40 124.0	14.88 148.8	16.53 165.3	19.84 198.4	24.80 248.0	29.76 297.6	30 300

- \* Gearhead and decimal gearhead are sold separately.
- \* The code in □ of gearhead model is for gear ratio.
- \*  color indicates that the output shaft of the geared motor rotates in the same direction as the output shaft of the motor. Others indicate rotation in the opposite direction.
- \* If you are to have less ratio than the ratio in the table, you can install the decimal gearhead, which has one tenth of the ratio, between the gearhead and the motor. In this case, the permissible torque is 3N·m/30kgf·cm.
- \* RPM is based on motor's synchronous rpm (50HZ:1500rpm, 60HZ:1800rpm) and calculated by dividing gear ratio. Actual rpm is 2~20% less than indicating rpm according to load size.

### CONNECTION DIAGRAMS

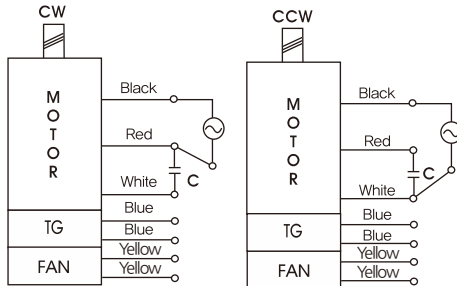

※The direction of motor rotation is as viewed from the front shaft end of the motor

## GEARHEAD

### DIMENSIONS

K9P□B



K9P□BF, BUF

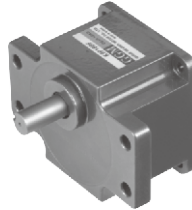

K9P□BU

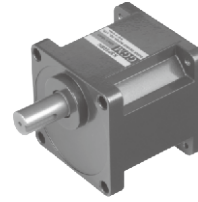

#### DECIMAL GEARHEAD

K9P10BX

#### KEY SPEC

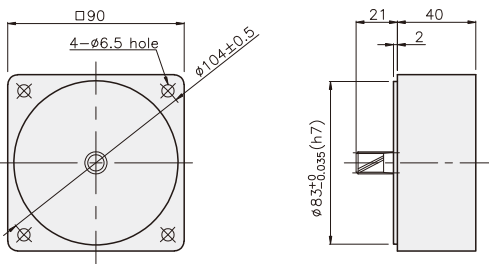

● KEY

● KEY GROOVE

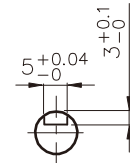
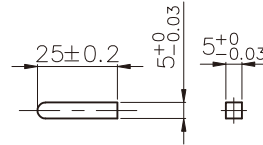

#### GEARHEAD

K9P□B

K9P□BF

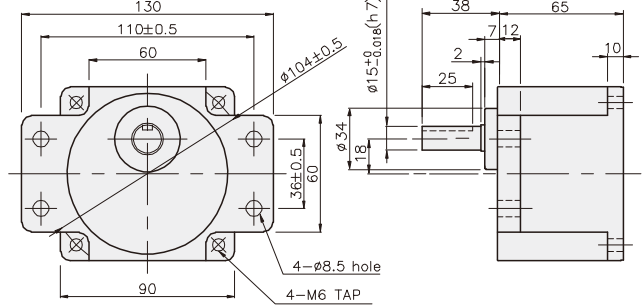
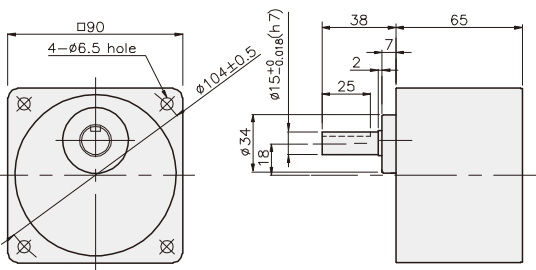

K9P□BU

K9P□BUF

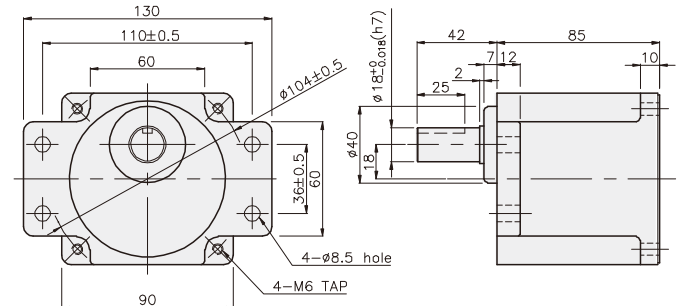
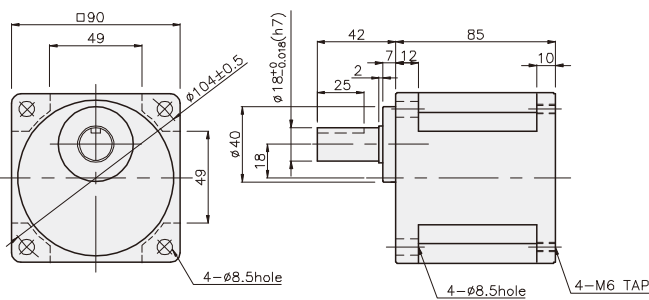

## GEARHEAD

### DIMENSIONS

K9RP90F□-SU + K9P□B

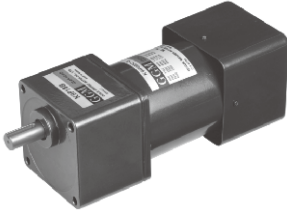

K9RP90F□-SU + K9P□BF, BUF

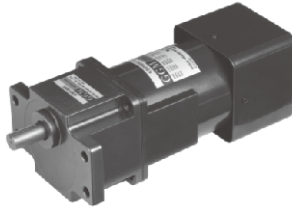

K9RP90F□-SU + K9P□BU

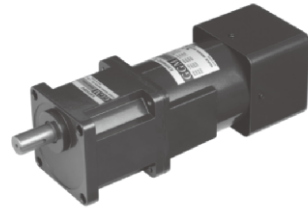

K9RP90F□-SU + K9P□B

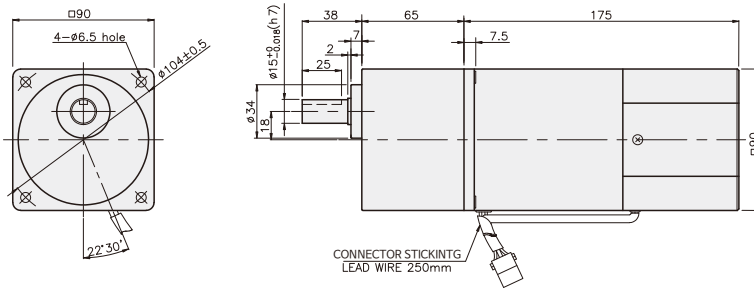

K9RP90F□-SU + K9P□BF

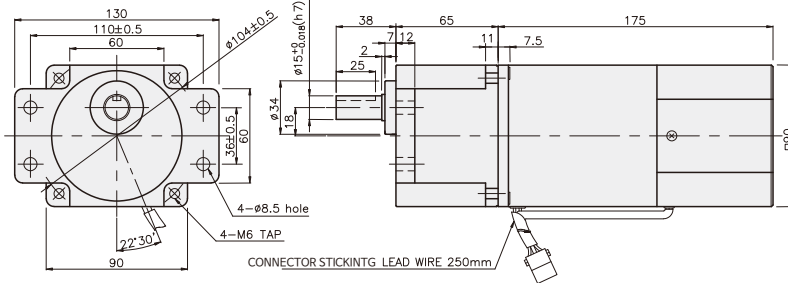

K9RP90F□-SU + K9P□BU

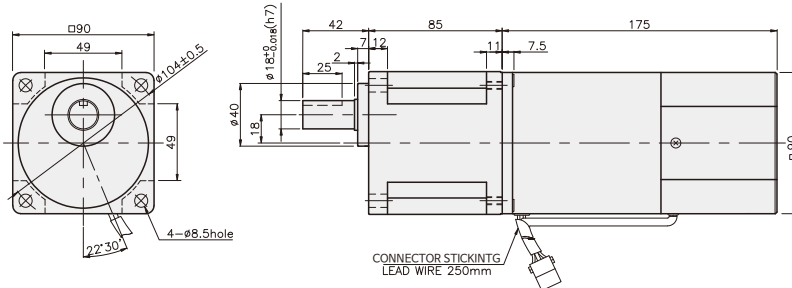

K9RP90F□-SU + K9P□BUF

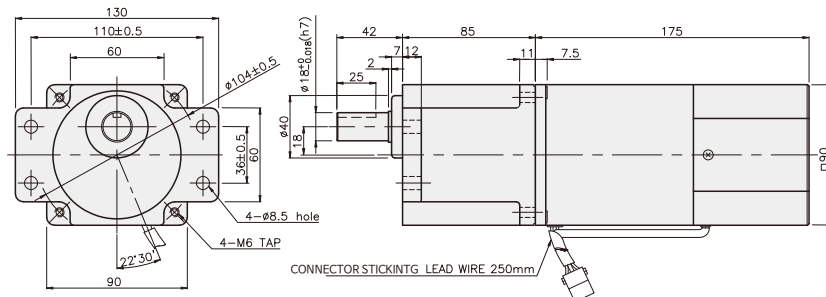

#### WEIGHT

PART	WEIGHT(kg)
MOTOR	3.06
DECIMAL GEARHEAD	0.62

#### DIMENSION TABLE

PART No.	Application Model	Mounting BOLT
01	K9P3~200B	M6 P1.0 × 95
02	K9P10BX	M6 P1.0 × 140

#### WEIGHT

PART	WEIGHT(kg)
K9P3~10B	1.22
K9P12.5~20B	1.32
K9P25~60B	1.42
K9P75~200B	1.45

#### DIMENSION TABLE

PART No.	Application Model	Mounting BOLT
01	K9P3~200BF	M6 P1.0 × 20
02	K9P10BX	M6 P1.0 × 65

#### WEIGHT

PART	WEIGHT(kg)
K9P3~10BF	1.22
K9P12.5~20BF	1.30
K9P25~60BF	1.42
K9P75~200BF	1.44

#### DIMENSION TABLE

PART No.	Application Model	Mounting BOLT
01	K9P3~200BU	M6 P1.0 × 20
02	K9P10BX	M6 P1.0 × 65

#### WEIGHT

PART	WEIGHT(kg)
K9P3~10BU	1.44
K9P12.5~20BU	1.55
K9P25~60BU	1.69
K9P75~200BU	1.74

#### DIMENSION TABLE

PART No.	Application Model	Mounting BOLT
01	K9P3~200BUF	M6 P1.0 × 20
02	K9P10BX	M6 P1.0 × 65

#### WEIGHT

PART	WEIGHT(kg)
K9P3~10BUF	1.50
K9P12.5~20BUF	1.62
K9P25~60BUF	1.76
K9P75~200BUF	1.82



## SPEED CONTROL MOTOR - SU SERIES

### 120W

### □90mm

### REVERSIBLE MOTOR

K9RS120F□-SU

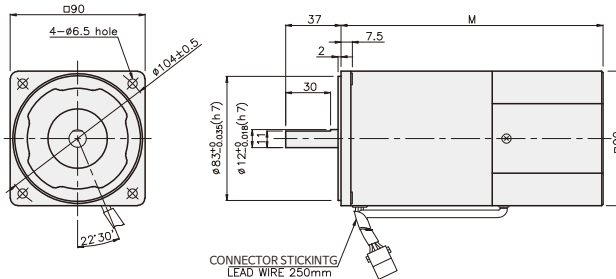
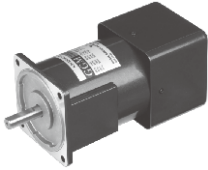

DIMENSION TABLE

PART No	M	Application Model
01	195	50Hz
02	175	60Hz

※ 50Hz motor is "C50" added to model number.

## SPECIFICATIONS

120W 30 minutes rating, four poles

Model	Maximum Out Put (w)	Voltage (V)	Frequency (Hz)	Speed Range (rpm)	Permissible Torque		Start T. (N·m/kgf·cm)	Current (A)	Condenser (μF)
					1200rpm	90rpm			
					(N·m/kgf·cm)	(N·m/kgf·cm)			
K9RP120FJ-SU K9RS120FJ-SU	120	100	50	90~1400	0.85	0.31	0.45/4.5	3.6	40
			60	90~1700	8.5	3.1			
K9RP120FU-SU K9RS120FU-SU	120	110	60	90~1700	0.8	0.28	0.4	3	25
		115							
K9RP120FL-SU K9RS120FL-SU	200	200	50	90~1400	0.8/8	0.27/2.7	0.37	1.4	8.5
			60	90~1700	0.78/7.8	0.29/2.9			
K9RP120FC-SU K9RS120FC-SU	120	220	50	90~1400	0.8	0.27	0.37	1.2	6
		230		90~1700					
		220	60	90~1400	0.78	0.29	0.42	1.4	7
		230		90~1700					
K9RP120FD-SU	120	240	50	90~1400	0.8/8	0.27/2.7	0.37/3.7	1.3	6

※ □ : SHAFT SHAPE ( S : STRAIGHT, P : PINION )

## RATED TORQUE OF GEARHEAD

### ● Single-phase 100V/115V

unit = above : N·m / below : kgf·cm

Model	Ratio	Speed(rpm)																								
		3	3.6	5	6	7.5	9	10	12.5	15	18	20	25	30	36	40	50	60	75	90	100	120	150	180	200	
K9R□120F□-SU K9P□B, BF	1200	100V/50/60Hz	2.07	2.48	3.44	4.13	5.16	6.20	6.89	7.75	9.29	11.15	12.39	13.94	16.73	20	20	20	20	20	20	20	20	20	20	20
		110V/115V/60Hz	1.94	2.33	3.24	3.89	4.86	5.83	6.48	7.29	8.75	10.50	11.66	13.12	15.75	18.90	20	20	20	20	20	20	20	20	20	20
	90	100V/50/60Hz	0.75	0.90	1.26	1.51	1.88	2.26	2.51	2.82	3.39	4.07	4.52	5.08	6.10	7.32	8.14	10.17	12.20	13.73	16.47	18.31	20	20	20	20
		110V/115V/60Hz	0.68	0.82	1.13	1.36	1.70	2.04	2.27	2.55	3.06	3.67	4.08	4.59	5.51	6.61	7.35	9.19	11.02	12.40	14.88	16.53	19.84	20	20	20

- \* Gearhead and decimal gearhead are sold separately.
- \* The code in □ of gearhead model is for gear ratio.
- \* ■ color indicates that the output shaft of the geared motor rotates in the same direction as the output shaft of the motor, Others indicate rotation in the opposite direction.
- \* If you are to have less ratio than the ratio in the table, you can install the decimal gearhead, which has one tenth of the ratio, between the gearhead and the motor. In this case, the permissible torque is 3N·m/30kgf·cm.
- \* RPM is based on motor's synchronous rpm (50HZ:1500rpm, 60HZ:1800rpm) and calculated by dividing gear ratio. Actual rpm is 2~20% less than indicating rpm according to load size.

## GEARHEAD

### RATED TORQUE OF GEARHEAD

#### ● Single-phase 200V/240V

unit = above : N·m / below : kgf·cm

Model Motor/Gearhead	Ratio Speed(rpm)	3	3.6	5	6	7.5	9	10	12.5	15	18	20	25	30	36	40	50	60	75	90	100	120	150	180	200	
		K9R□120F□-SU K9P□B, BF	1200	200V/220V/ 230V/240V 50Hz	1.94 19.4	2.33 23.3	3.24 32.4	3.89 38.9	4.86 48.6	5.38 53.8	6.48 64.8	7.29 72.9	8.75 87.5	10.50 105.0	11.66 116.6	13.12 131.2	15.75 157.5	18.90 189.0	20	20	20	20	20	20	20	20
200V/220V/ 230V 60Hz	1.90 19.0			2.27 22.7	3.16 31.6	3.79 37.9	4.74 47.4	5.69 56.9	6.32 63.2	7.11 71.1	8.53 85.3	10.24 102.4	11.37 113.7	12.79 127.9	15.35 153.5	18.42 184.2	20	20	20	20	20	20	20	20	20	20
90	200V/220V/ 230V/240V 50Hz		0.66 6.6	0.79 7.9	1.09 10.9	1.31 13.1	1.64 16.4	1.97 19.7	2.19 21.9	2.46 24.6	2.95 29.5	3.54 35.4	3.94 39.4	4.43 44.3	5.31 53.1	6.38 63.8	7.09 70.9	8.86 88.6	10.63 106.3	11.96 119.6	14.35 143.5	15.94 159.4	19.13 191.3	20	20	20
	200V/220V/ 230V 60Hz		0.70 7.0	0.85 8.5	1.17 11.7	1.41 14.1	1.76 17.6	2.11 21.1	2.35 23.5	2.64 26.4	3.17 31.7	3.81 38.1	4.23 42.3	4.76 47.6	5.71 57.1	6.85 68.5	7.61 76.1	9.51 95.1	11.42 114.2	12.84 128.4	15.41 154.1	17.12 171.2	20	20	20	20

#### ● Single-phase 100V/115V

unit = above : N·m / below : kgf·cm

Model Motor/Gearhead	Ratio Speed(rpm)	3	3.6	5	6	7.5	9	10	12.5	15	18	20	25	30	36	40	50	60	75	90	100	120	150	180	200	
		K9R□120F□-SU K9P□BU, BUF	1200	100V 50/60Hz	2.07 20.7	2.48 24.8	3.44 34.4	4.13 41.3	5.16 51.6	6.20 62.0	6.89 68.9	7.75 77.5	9.29 92.9	11.15 111.5	12.39 123.9	13.94 139.4	16.73 167.3	20.08 201	22.31 223	27.88 279	30	30	30	30	30	30
110V/115V 60Hz	1.94 19.4			2.33 23.3	3.24 32.4	3.89 38.9	4.86 48.6	5.83 58.3	6.48 64.8	7.29 72.9	8.75 87.5	10.50 105.0	11.66 116.6	13.12 131.2	15.75 157.5	18.90 189.0	21.00 210	26.24 262	30	30	30	30	30	30	30	30
90	100V 50/60Hz		0.75 7.5	0.90 9.0	1.26 12.6	1.51 15.1	1.88 18.8	2.26 22.6	2.51 25.1	2.82 28.2	3.39 33.9	4.07 40.7	4.52 45.2	5.08 50.8	6.10 61.0	7.32 73.2	8.14 81.4	10.17 101.7	12.20 122.0	13.73 137.3	16.47 164.7	18.31 183.1	21.97 219.7	27.46 274.6	30	30
	110V/115V 60Hz		0.68 6.8	0.82 8.2	1.13 11.3	1.36 13.6	1.70 17.0	2.04 20.4	2.27 22.7	2.55 25.5	3.06 30.6	3.67 36.7	4.08 40.8	4.59 45.9	5.51 55.1	6.61 66.1	7.35 73.5	9.19 91.9	11.02 110.2	12.40 124.0	14.88 148.8	16.53 165.3	19.84 198.4	24.80 248.0	29.76 297.6	30

#### ● Single-phase 200V/240V

unit = above : N·m / below : kgf·cm

Model Motor/Gearhead	Ratio Speed(rpm)	3	3.6	5	6	7.5	9	10	12.5	15	18	20	25	30	36	40	50	60	75	90	100	120	150	180	200	
		K9R□120F□-SU K9P□BU, BUF	1200	200V/220V/ 230V/240V 50Hz	1.94 19.4	2.33 23.3	3.24 32.4	3.89 38.9	4.86 48.6	5.83 58.3	6.48 64.8	7.29 72.9	8.75 87.5	10.50 105.0	11.66 116.6	13.12 131.2	15.75 157.5	18.90 189.0	21.00 210.0	26.24 262.4	30	30	30	30	30	30
200V/220V/ 230V/60Hz	1.90 19.0			2.27 22.7	3.16 31.6	3.79 37.9	4.74 47.4	5.69 56.9	6.32 63.2	7.11 71.1	8.53 85.3	10.24 102.4	11.37 113.7	12.79 127.9	15.35 153.5	18.42 184.2	20.47 204.7	25.59 255.9	30	30	30	30	30	30	30	30
90	200V/220V/ 230V/240V 50Hz		0.66 6.6	0.79 7.9	1.09 10.9	1.31 13.1	1.64 16.4	1.97 19.7	2.19 21.9	2.46 24.6	2.95 29.5	3.54 35.4	3.94 39.4	4.43 44.3	5.31 53.1	6.38 63.8	7.09 70.9	8.86 88.6	10.63 106.3	11.96 119.6	14.35 143.5	15.94 159.4	19.13 191.3	23.91 239.1	28.70 287.0	30
	200V/220V/ 230V/60Hz		0.70 7.0	0.85 8.5	1.17 11.7	1.41 14.1	1.76 17.6	2.11 21.1	2.35 23.5	2.64 26.4	3.17 31.7	3.81 38.1	4.23 42.3	4.76 47.6	5.71 57.1	6.85 68.5	7.61 76.1	9.51 95.1	11.42 114.2	12.84 128.4	15.41 154.1	17.12 171.2	20.55 205.5	25.69 256.9	30	30

- \* Gearhead and decimal gearhead are sold separately.
- \* The code in □ of gearhead model is for gear ratio.
- \*   color indicates that the output shaft of the geared motor rotates in the same direction as the output shaft of the motor. Others indicate rotation in the opposite direction.
- \* If you are to have less ratio than the ratio in the table, you can install the decimal gearhead, which has one tenth of the ratio, between the gearhead and the motor. In this case, the permissible torque is 3N·m/30kgf·cm.
- \* RPM is based on motor's synchronous rpm (50HZ:1500rpm, 60HZ:1800rpm) and calculated by dividing gear ratio. Actual rpm is 2~20% less than indicating rpm according to load size.

### CONNECTION DIAGRAMS

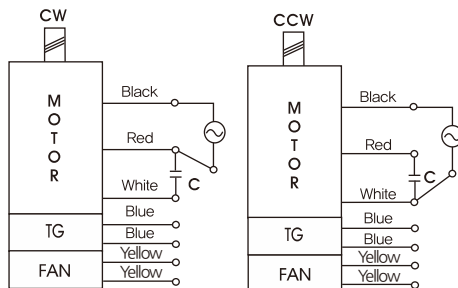

※The direction of motor rotation is as viewed from the front shaft end of the motor

## GEARHEAD

### DIMENSIONS

K9P□B



K9P□BF, BUF

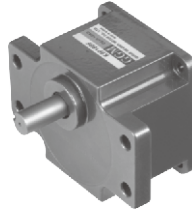

K9P□BU

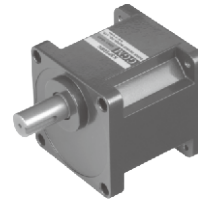

#### DECIMAL GEARHEAD

K9P10BX

#### KEY SPEC

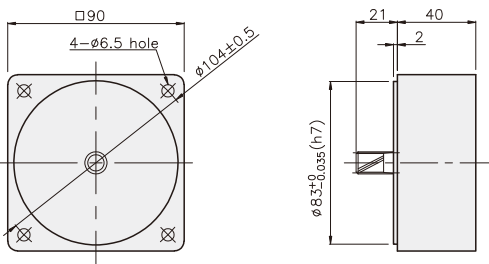

● KEY

● KEY GROOVE

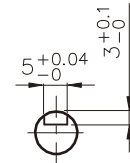
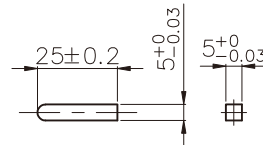

#### GEARHEAD

K9P□B

K9P□BF

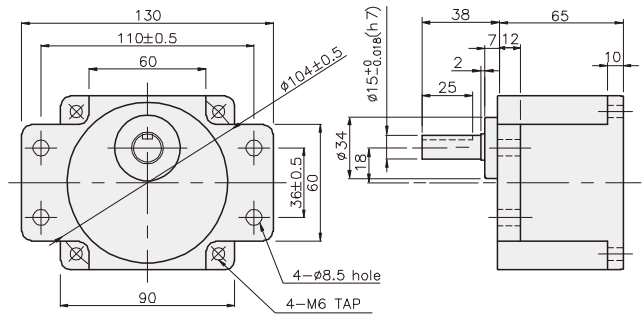
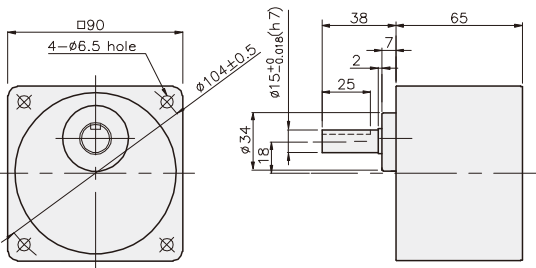

K9P□BU

K9P□BUF

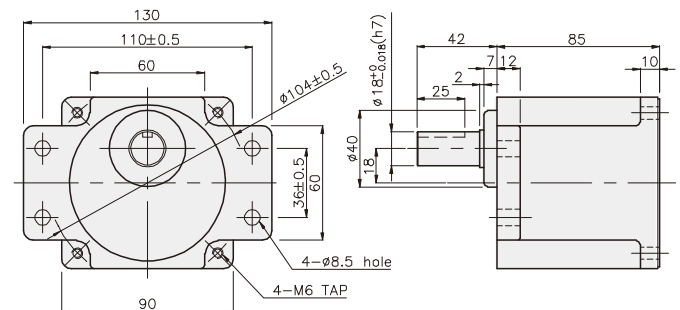
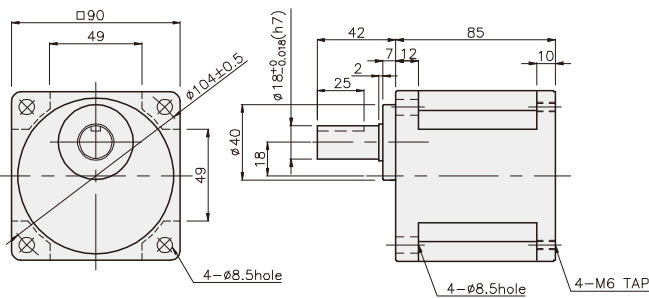

## GEARHEAD

### DIMENSIONS

K9RP120F□-SU + K9P□B

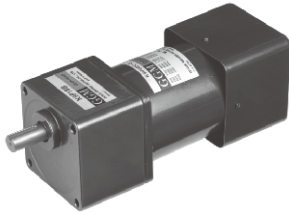

K9RP120F□-SU + K9P□BF, BUF

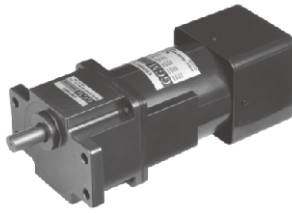

K9RP120F□-SU + K9P□BU

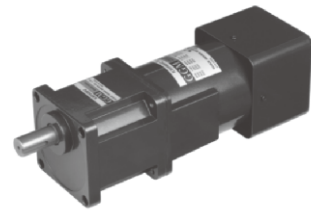

K9RP120F□-SU + K9P□B

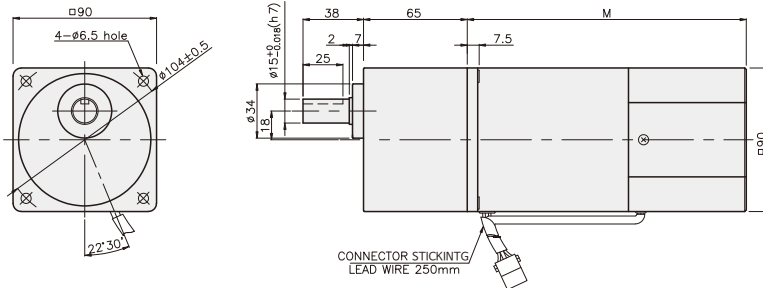

K9RP120F□-SU + K9P□BF

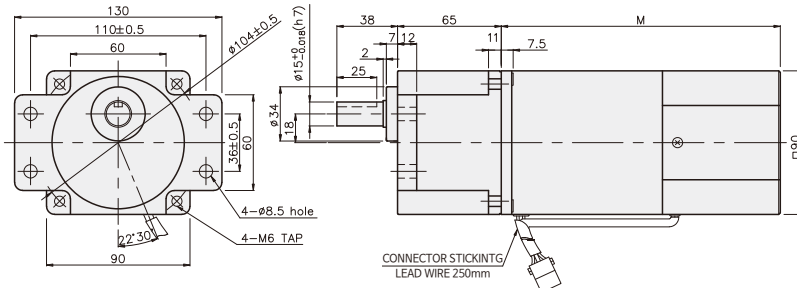

K9RP120F□-SU + K9P□BU

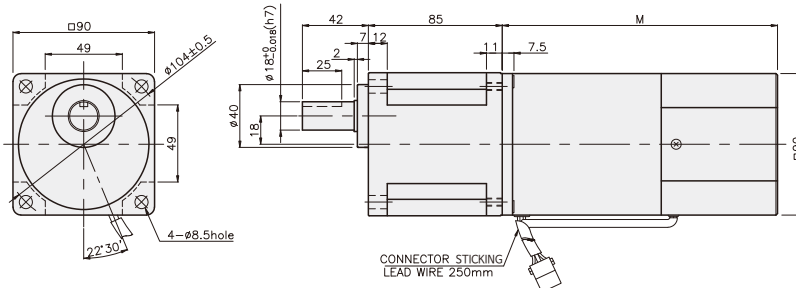

K9RP120F□-SU + K9P□BUF

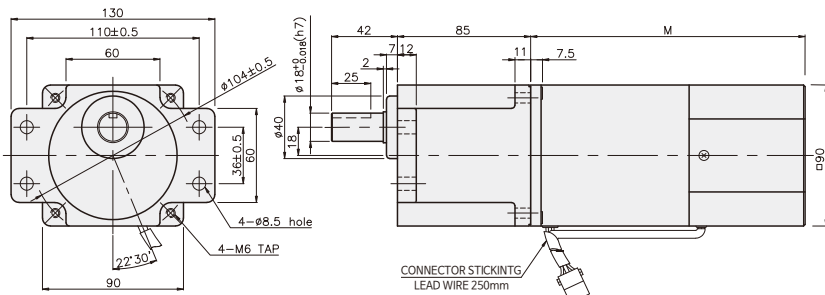

#### WEIGHT

PART	WEIGHT(kg)
MOTOR	3.54
DECIMAL GEARHEAD	0.62

#### DIMENSION TABLE

PART No.	M	Application Model
01	155	50Hz
02	135	60Hz

#### DIMENSION TABLE

PART No.	Application Model	Mounting BOLT
01	K9P3~200B	M6 P1.0 × 95
02	K9P10BX	M6 P1.0 × 140

#### WEIGHT

PART	WEIGHT(kg)
K9P3~10B	1.22
K9P12.5~20B	1.32
K9P25~60B	1.42
K9P75~200B	1.45

#### DIMENSION TABLE

PART No.	Application Model	Mounting BOLT
01	K9P3~200BF	M6 P1.0 × 20
02	K9P10BX	M6 P1.0 × 65

#### WEIGHT

PART	WEIGHT(kg)
K9P3~10BF	1.22
K9P12.5~20BF	1.30
K9P25~60BF	1.42
K9P75~200BF	1.44

#### DIMENSION TABLE

PART No.	Application Model	Mounting BOLT
01	K9P3~200BU	M6 P1.0 × 20
02	K9P10BX	M6 P1.0 × 65

#### WEIGHT

PART	WEIGHT(kg)
K9P3~10BU	1.44
K9P12.5~20BU	1.55
K9P25~60BU	1.69
K9P75~200BU	1.74

#### DIMENSION TABLE

PART No.	Application Model	Mounting BOLT
01	K9P3~200BUF	M6 P1.0 × 20
02	K9P10BX	M6 P1.0 × 65

#### WEIGHT

PART	WEIGHT(kg)
K9P3~10BUF	1.50
K9P12.5~20BUF	1.62
K9P25~60BUF	1.76
K9P75~200BUF	1.82

## SPEED CONTROL MOTOR - SU SERIES

180W

□90mm

REVERSIBLE MOTOR

K9R180F□-SU

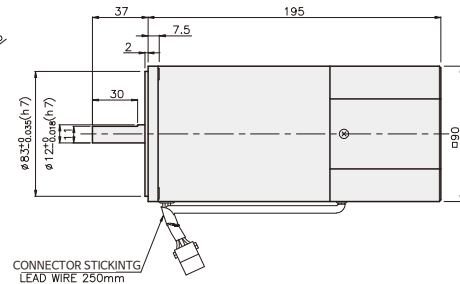
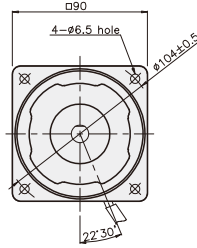
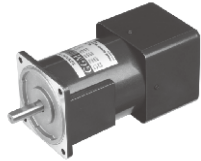

### SPECIFICATIONS

180W 30 minutes rating, four poles

Model	Maximum Out Put (W)	Voltage (V)	Frequency (Hz)	Speed Range (rpm)	Permissible Torque		Start T. (N·m/kgf·cm)	Current (A)	Condenser (μF)
					1200rpm	90rpm			
					(N·m/kgf·cm)	(N·m/kgf·cm)			
K9RP180FJ-SU K9RS180FJ-SU	180	100	50	90~1400	0.88	0.33	0.5	5	40
			60	90~1700	8.8	3.3	5	4.8	
K9RP180FU-SU K9RS180FU-SU	180	110	60	90~1700	1.1	0.38	0.58	5	40
		115						5.8	
K9RP180FL-SU K9RS180FL-SU	180	200	50	90~1400	0.88	0.3	0.45/4.5	2.2	12
			60	90~1700	8.8	3	0.38/3.8		
K9RP180FC-SU K9RS180FC-SU	180	220	50	90~1400	0.88	0.3	0.42/4.2	2.2	8
			60	90~1700	8.8	3	0.38/3.8	2	
		230	50	90~1400	0.95	0.32	0.48/4.8	2.4	
			60	90~1700	9.5	3.2	0.45/4.5	2.2	
K9RP180FD-SU K9RS180FD-SU	180	240	50	90~1400	0.95	0.32	0.55/5.5	2	8

※ □ : SHAFT SHAPE ( S : STRAIGHT, P : PINION )

### RATED TORQUE OF GEARHEAD

#### ● Single-phase 100V/115V

unit = above : N·m / below : kgf·cm

Model	Ratio	Speed(rpm)																								
		3	3.6	5	6	7.5	9	10	12.5	15	18	20	25	30	36	40	50	60	75	90	100	120	150	180	200	
K9R□180F□-SU	1200	2.14	2.57	3.56	4.28	5.35	6.42	7.13	8.02	9.62	11.55	12.83	14.43	17.32	20.79	23.09	28.87	30	30	30	30	30	30	30	30	30
	110V/115V 60Hz	2.67	3.21	4.46	5.35	6.68	8.02	8.91	10.02	12.03	14.43	16.04	18.04	21.65	25.98	28.87	30	30	30	30	30	30	30	30	30	30
K9P□BU, BUF	90	0.80	0.96	1.34	1.60	2.00	2.41	2.67	3.01	3.61	4.33	4.81	5.41	6.50	7.79	8.66	10.83	12.99	14.61	17.54	19.49	23.38	29.23	30	30	
	110V/115V 60Hz	0.92	1.11	1.54	1.85	2.31	2.77	3.08	3.46	4.16	4.99	5.54	6.23	7.48	8.98	9.97	12.47	14.96	16.83	20.19	22.44	26.93	30	30	30	

\* Gearhead and decimal gearhead are sold separately.

\* The code in □ of gearhead model is for gear ratio.

\*      color indicates that the output shaft of the geared motor rotates in the same direction as the output shaft of the motor. Others indicate rotation in the opposite direction.

\* If you are to have less ratio than the ratio in the table, you can install the decimal gearhead, which has one tenth of the ratio, between the gearhead and the motor. In this case, the permissible torque is 3N·m/30kgf·cm.

\* RPM is based on motor's synchronous rpm (50HZ:1500rpm, 60HZ:1800rpm) and calculated by dividing gear ratio. Actual rpm is 2~20% less than indicating rpm according to load size.

## GEARHEAD

### RATED TORQUE OF GEARHEAD

#### ● Single-phase 200V/240V

unit = above : N·m / below : kgf·cm

Model Motor/Gearhead	Ratio Speed(rpm)	3	3.6	5	6	7.5	9	10	12.5	15	18	20	25	30	36	40	50	60	75	90	100	120	150	180	200	
		K9R□180F□- SU K9P□BU, BUF	1200	200V/220V 50Hz/60Hz	2.14 21.4	2.57 25.7	3.56 35.6	4.28 42.8	5.35 53.5	6.42 64.2	7.13 71.3	8.02 80.2	9.62 96.2	11.55 115.5	12.83 128.3	14.43 144.3	17.32 173.2	20.79 207.9	23.09 230.9	28.87 288.7	30	30	30	30	30	30
230V 50Hz/60Hz 240V/50Hz	2.31 23.1			2.77 27.7	3.85 38.5	4.62 46.2	5.77 57.7	6.93 69.3	7.70 77.0	8.66 86.6	10.39 103.9	12.47 124.7	13.85 138.5	15.58 155.8	18.70 187.0	22.44 224.4	24.93 249.3	30	30	30	30	30	30	30	20	30
90	200V/220V 50Hz/60Hz		0.73 7.3	0.87 8.7	1.22 12.2	1.46 14.6	1.82 18.2	2.19 21.9	2.43 24.3	2.73 27.3	3.28 32.8	3.94 39.4	4.37 43.7	4.92 49.2	5.90 59.0	7.09 70.9	7.87 78.7	9.84 98.4	11.81 118.1	13.29 132.9	15.94 159.4	17.71 177.1	21.26 212.6	26.57 265.7	30	30
	230V 50Hz/60Hz 240V/50Hz		0.78 7.8	0.93 9.3	1.30 13.0	1.56 15.6	1.94 19.4	2.33 23.3	2.59 25.9	2.92 29.2	3.50 35.0	4.20 42.0	4.67 46.7	5.25 52.5	6.30 63.0	7.56 75.6	8.40 84.0	10.50 105.0	12.60 126.0	14.17 141.7	17.01 170.1	18.90 189.0	22.67 226.7	28.34 283.4	30	30

#### ● Single-phase 100V/115V

unit = above : N·m / below : kgf·cm

Model Motor/Gearhead	Ratio Speed(rpm)	3	3.6	5	6	7.5	9	10	12.5	15	18	20	25	30	36	40	50	60	75	90	100	120	150	180	200	
		K9R□180F□- DK9P□BU	1200	100V 50/60Hz	2.14 21.4	2.57 25.7	3.56 35.6	4.28 42.8	5.35 53.5	6.42 64.2	7.13 71.3	8.02 80.2	9.62 96.2	11.55 115.5	12.83 128.3	14.43 144.3	17.32 173.2	20.79 207.9	23.09 230.9	28.87 288.7	30	30	30	30	30	30
110V/115V 60Hz	2.67 26.7			3.21 32.1	4.46 44.6	5.35 53.5	6.68 66.8	8.02 80.2	8.91 89.1	10.02 100.2	12.03 120.3	14.43 144.3	16.04 160.4	18.04 180.4	21.65 216.5	25.98 259.8	28.87 288.7	30	30	30	30	30	30	30	30	30
90	100V 50/60Hz		0.80 8.0	0.96 9.6	1.34 13.4	1.60 16.0	2.00 20.0	2.41 24.1	2.67 26.7	3.01 30.1	3.61 36.1	4.33 43.3	4.81 48.1	5.41 54.1	6.50 65.0	7.79 77.9	8.66 86.6	10.83 108.3	12.99 129.9	14.61 146.1	17.54 175.4	19.49 194.9	23.38 233.8	29.23 292.3	30	30
	110V/115V 60Hz		0.92 9.2	1.11 11.1	1.54 15.4	1.85 18.5	2.31 23.1	2.77 27.7	3.08 30.8	3.46 34.6	4.16 41.6	4.99 49.9	5.54 55.4	6.23 62.3	7.48 74.8	8.98 89.8	9.97 99.7	12.47 124.7	14.96 149.6	16.83 168.3	20.19 201.9	22.44 224.4	26.93 269.3	30	30	30

#### ● Single-phase 200V/240V

unit = above : N·m / below : kgf·cm

Model Motor/Gearhead	Ratio Speed(rpm)	3	3.6	5	6	7.5	9	10	12.5	15	18	20	25	30	36	40	50	60	75	90	100	120	150	180	200	
		K9R□180F□- DK9P□BU	1200	200V/220V 50Hz/60Hz	2.14 21.4	2.57 25.7	3.56 35.6	4.28 42.8	5.35 53.5	6.42 64.2	7.13 71.3	8.02 80.2	9.62 96.2	11.55 115.5	12.83 128.3	14.43 144.3	17.32 173.2	20.79 207.9	23.09 230.9	28.87 288.7	30	30	30	30	30	30
230V 50Hz/60Hz 240V/50Hz	2.31 23.1			2.77 27.7	3.85 38.5	4.62 46.2	5.77 57.7	6.93 69.3	7.70 77.0	8.66 86.6	10.39 103.9	12.47 124.7	13.85 138.5	15.58 155.8	18.70 187.0	22.44 224.4	24.93 249.3	30	30	30	30	30	30	30	20	30
90	200V/220V 50Hz/60Hz		0.73 7.3	0.87 8.7	1.22 12.2	1.46 14.6	1.82 18.2	2.19 21.9	2.43 24.3	2.73 27.3	3.28 32.8	3.94 39.4	4.37 43.7	4.92 49.2	5.90 59.0	7.09 70.9	7.87 78.7	9.84 98.4	11.81 118.1	13.29 132.9	15.94 159.4	17.71 177.1	21.26 212.6	26.57 265.7	30	30
	230V 50Hz/60Hz 240V/50Hz		0.78 7.8	0.93 9.3	1.30 13.0	1.56 15.6	1.94 19.4	2.33 23.3	2.59 25.9	2.92 29.2	3.50 35.0	4.20 42.0	4.67 46.7	5.25 52.5	6.30 63.0	7.56 75.6	8.40 84.0	10.50 105.0	12.60 126.0	14.17 141.7	17.01 170.1	18.90 189.0	22.67 226.7	28.34 283.4	30	30

#### ● Single-phase 100V/115V

unit = above : N·m / below : kgf·cm

Model Motor/Gearhead	Ratio Speed(rpm)	3	3.6	5	6	7.5	9	10	12.5	15	18	20	25	30	36	40	50	60	75	90	100	120	150	180	200	
		K9R□180F□- DK9P□BU	1200	100V 50/60Hz	2.14 21.4	2.57 25.7	3.56 35.6	4.28 42.8	5.35 53.5	6.42 64.2	7.13 71.3	8.02 80.2	9.62 96.2	11.55 115.5	12.83 128.3	14.43 144.3	17.32 173.2	20.79 207.9	23.09 230.9	28.87 288.7	30	30	30	30	30	30
110V/115V 60Hz	2.67 26.7			3.21 32.1	4.46 44.6	5.35 53.5	6.68 66.8	8.02 80.2	8.91 89.1	10.02 100.2	12.03 120.3	14.43 144.3	16.04 160.4	18.04 180.4	21.65 216.5	25.98 259.8	28.87 288.7	30	30	30	30	30	30	30	30	30
90	100V 50/60Hz		0.80 8.0	0.96 9.6	1.34 13.4	1.60 16.0	2.00 20.0	2.41 24.1	2.67 26.7	3.01 30.1	3.61 36.1	4.33 43.3	4.81 48.1	5.41 54.1	6.50 65.0	7.79 77.9	8.66 86.6	10.83 108.3	12.99 129.9	14.61 146.1	17.54 175.4	19.49 194.9	23.38 233.8	29.23 292.3	30	30
	110V/115V 60Hz		0.92 9.2	1.11 11.1	1.54 15.4	1.85 18.5	2.31 23.1	2.77 27.7	3.08 30.8	3.46 34.6	4.16 41.6	4.99 49.9	5.54 55.4	6.23 62.3	7.48 74.8	8.98 89.8	9.97 99.7	12.47 124.7	14.96 149.6	16.83 168.3	20.19 201.9	22.44 224.4	26.93 269.3	30	30	30

#### ● Single-phase 200V/240V

unit = above : N·m / below : kgf·cm

Model Motor/Gearhead	Ratio Speed(rpm)	3	3.6	5	6	7.5	9	10	12.5	15	18	20	25	30	36	40	50	60	75	90	100	120	150	180	200	
		K9R□180F□- DK9P□BU	1200	200V/220V 50Hz/60Hz	2.14 21.4	2.57 25.7	3.56 35.6	4.28 42.8	5.35 53.5	6.42 64.2	7.13 71.3	8.02 80.2	9.62 96.2	11.55 115.5	12.83 128.3	14.43 144.3	17.32 173.2	20.79 207.9	23.09 230.9	28.87 288.7	30	30	30	30	30	30
230V 50Hz/60Hz 240V/50Hz	2.31 23.1			2.77 27.7	3.85 38.5	4.62 46.2	5.77 57.7	6.93 69.3	7.70 77.0	8.66 86.6	10.39 103.9	12.47 124.7	13.85 138.5	15.58 155.8	18.70 187.0	22.44 224.4	24.93 249.3	30	30	30	30	30	30	30	20	30
90	200V/220V 50Hz/60Hz		0.73 7.3	0.87 8.7	1.22 12.2	1.46 14.6	1.82 18.2	2.19 21.9	2.43 24.3	2.73 27.3	3.28 32.8	3.94 39.4	4.37 43.7	4.92 49.2	5.90 59.0	7.09 70.9	7.87 78.7	9.84 98.4	11.81 118.1	13.29 132.9	15.94 159.4	17.71 177.1	21.26 212.6	26.57 265.7	30	30
	230V 50Hz/60Hz 240V/50Hz		0.78 7.8	0.93 9.3	1.30 13.0	1.56 15.6	1.94 19.4	2.33 23.3	2.59 25.9	2.92 29.2	3.50 35.0	4.20 42.0	4.67 46.7	5.25 52.5	6.30 63.0	7.56 75.6	8.40 84.0	10.50 105.0	12.60 126.0	14.17 141.7	17.01 170.1	18.90 189.0	22.67 226.7	28.34 283.4	30	30

- \* Gearhead and decimal gearhead are sold separately.
- \* The code in □ of gearhead model is for gear ratio.
- \* ■ color indicates that the output shaft of the geared motor rotates in the same direction as the output shaft of the motor. Others indicate rotation in the opposite direction.
- \* If you are to have less ratio than the ratio in the table, you can install the decimal gearhead, which has one tenth of the ratio, between the gearhead and the motor. In this case, the permissible torque is 3N·m/30kgf·cm.
- \* RPM is based on motor's synchronous rpm (50HZ:1500rpm, 60HZ:1800rpm) and calculated by dividing gear ratio. Actual rpm is 2~20% less than indicating rpm according to load size.



## GEARHEAD

### CONNECTION DIAGRAMS

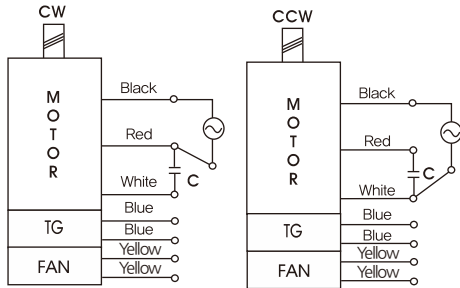

※The direction of motor rotation is as viewed from the front shaft end of the motor

### DIMENSIONS

K9P□BU

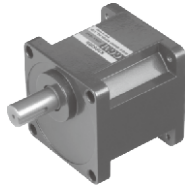

K9P□BUF

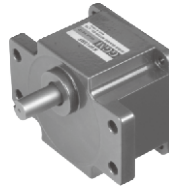

#### DECIMAL GEARHEAD

K9P10BX

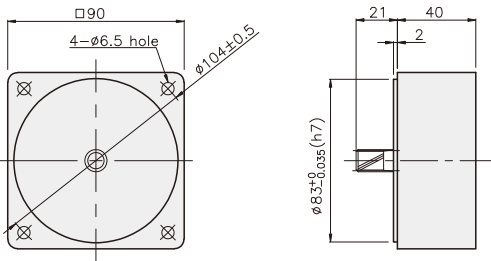

#### KEY SPEC

● KEY

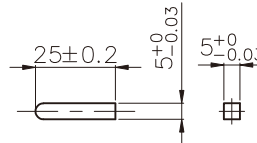

● KEY GROOVE

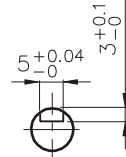

#### GEARHEAD

K9P□BU

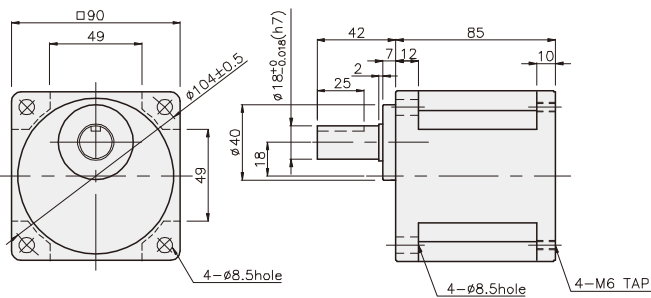

K9P□BUF

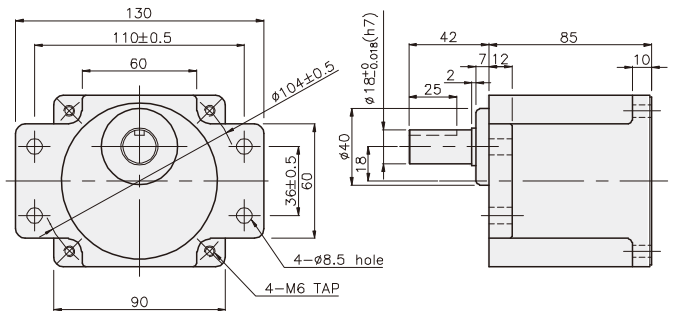



## GEARHEAD

### DIMENSIONS

K9RP180F□-SU + K9P□BU

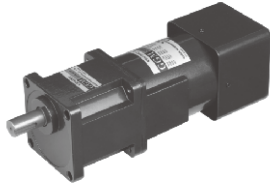

K9RP180F□-SU + K9P□BUF

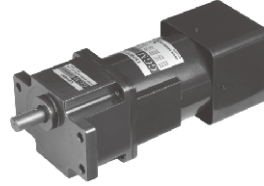

#### WEIGHT

PART	WEIGHT(kg)
MOTOR	4.24
DECIMAL GEARHEAD	0.62

#### DIMENSION TABLE

PART No.	Application Model	Mounting BOLT
01	K9P3~200BU	M6 P1.0 × 20
02	K9P10BX	M6 P1.0 × 65

#### WEIGHT

PART	WEIGHT(kg)
K9P3~10BU	1.44
K9P12.5~20BU	1.55
K9P25~60BU	1.69
K9P75~200BU	1.74

#### DIMENSION TABLE

PART No.	Application Model	Mounting BOLT
01	K9P3~200BUF	M6 P1.0 × 20
02	K9P10BX	M6 P1.0 × 65

#### WEIGHT

PART	WEIGHT(kg)
K9P3~10BUF	1.50
K9P12.5~20BUF	1.62
K9P25~60BUF	1.76
K9P75~200BUF	1.82

K9RP180F□-SU + K9P□BU

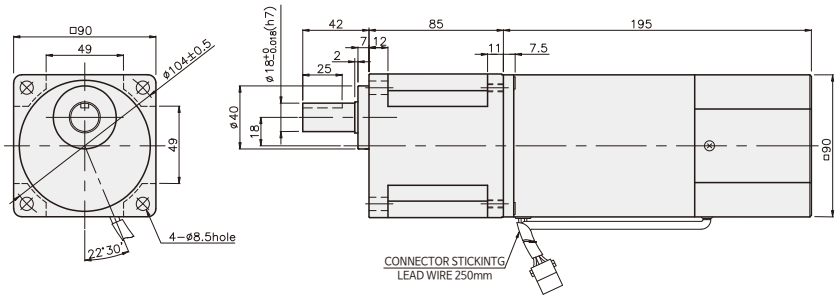

K9RP180F□-SU + K9P□BUF

